



KA-6027 27pcs 3/4" Dr. Socket Wrench Set

- Chrome vanadium steel
- Contents:
 - 1PC-20" reversible Ratchet Handle
 - 1PC-18" Sliding "T" Bar
 - 1PC-4" Extension Bar
 - 1PC-8" Extension Bar
 - 1PC-Metal Box 21" x 7" x 3-1/16"
 - 12PC-12pt. Sockets (inch size):
 - 7/8", 15/16", 1", 1-1/8", 1-3/16", 1-5/16", 1-3/8",
 - 1-7/16", 1-5/8", 1-3/4", 1-7/8", 2"
 - 10PC-12pt. Sockets (metric size):
 - 22, 24, 27, 30, 32, 36, 38, 41, 46, 50mm



KT-4043 43pcs 1/2" Dr. Socket Set

- Contents:
 - 33PC-12pt. Socket
 - 10, 11, 12, 13, 14, 15, 16, 17, 18, 19, 20, 21, 22, 23, 24,
 - 27, 30, 32mm
 - 3/8", 7/16", 1/2", 9/16", 5/8", 11/16", 3/4", 13/16", 7/8",
 - 15/16", 1", 1-1/16", 1-1/8", 1-3/16", 1-1/4"
 - 1PC-Ratchet Handle
 - 2PC-Extension Bar 5" & 10"
 - 2PC-Spark Plug Socket 16mm & 21mm
 - 1PC-Sliding T Handle
 - 1PC-Universal Joint



KT-3039 39pcs 3/8" Dr. Socket Set

- Contents:
 - 9PC-3/8" Dr. Socket x 12pt.(METRIC)
 - 9, 10, 11, 12, 13, 14, 16, 17, 19mm
 - 7PC-3/8" Dr. Socket x 12pt (SAE)
 - 3/8", 7/16", 1/2", 9/16", 5/8", 11/16", 3/4"
 - 9PC-1/4" Dr. Socket x 6pt (METRIC)
 - 4, 5, 6, 7, 8, 9, 10, 11, 12mm
 - 9PC-1/4" Dr. Socket x 6pt (SAE)
 - 3/16", 7/32", 1/4", 9/32", 5/16", 11/32", 3/8", 7/16", 1/2"
 - 1PC-Spinner Handle
 - 1PC-Extension Bar 3"
 - 1PC-3/8" x 1/4" Adapter
 - 1PC-3/8" x 5/8" Spark Plug
 - 1PC-3/8" Dr. Ratchet Handle



KA-1120 19pcs 3/8" Dr. Socket Wrench Set

- 13-3/8" dr. socket (6pt): 10-11-12-13-14-15-16-17-18-19-20-21-22-24mm
- 2-Extension Bar: 125mm & 150mm
- 1-Sliding T Bar
- 1-Flexible Handle 12"
- 1-Ratchet Handle



KA-1121 40pcs 3/8" Dr. Super Lock Socket Wrench Set

- 19-socket: 6-7-8-9-10-11-12-13-14-15-16-17-18-19-20-21-22-23-24mm
- 15-deep socket: 6-7-8-9-10-11-12-13-14-15-16-17-18-19-21mm
- 1-Ratchet Handle Offset Type-72 Teeth (quick release)
- 3-Extension Bar: 44-75-150mm
- 1-Flex Handle Standard 200mm
- 1-Universal Joint W/Screw



KA-1122 26pcs 3/8" Dr. Socket Wrench Set

18-3/8"dr.socket (6pt):
 6-7-8-9-10-11-12-13-14-15-16-17-18-19-20-21-22-24mm
 3-Extension Bar: 1-3/4", 3" & 6"
 2-Spark Plug Socket: 16, 21mm
 1-Oval Ratchet Handle (quick release)
 1-Universal Joint
 1-TM-HEAD 3/8" dr.(M) x 1/2"dr.(F)



KA-1123 27pcs 3/8" Dr. Socket Wrench Set

18-3/8"dr.socket (6pt):
 6-7-8-9-10-11-12-13-14-15-16-17-18-19-20-21-22-23mm
 1-Oval Ratchet Handle (quick release)
 3-Extension Bar: 1-3/4", 3" & 6"
 2-Spark Plug Socket: 16, 21mm
 1-TM-HEAD 3/8" dr.(M) x 1/2"dr.(F)
 1-Universal Joint



KA-1124 25pcs 3/8" Dr. Super Lock Socket Wrench Set

13-Super Lock Sockets:
 6-7-8-9-10-11-12-13-14-15-16-17-19-20-22-24mm
 2-3/8"dr.extension bar 75 & 150mm (3" & 6")
 1-Sliding. T-Handle 200mm(8")
 1-Oval Ratchet Handle (quick release)
 2-3/8"dr.spark plug: 16 & 21mm
 1-3/8"dr.universal joint
 14-bit socket: 90mm(L) Spline: M8, M10, M12
 48mm(L) Hex:5, 6, 7, 8, 10 & Torx: T15, T20, T25, T30, T40



KA-1302 29pcs 1/4" Dr. Socket Wrench Set

12-Socket: 4-4.5-5-5.5-6-7-8-9-10-11-12-13mm
 1-Extension bar 2"
 1-Spinner handle
 1-Sliding T Bar
 1-Oval ratchet handle (quick release)
 1-Universal joint
 3-Slotted type: 4-5.5-7mm
 5-Hex type: 3-4-5-6-8mm
 2-Phillips: #1-#2
 2-Pozidrive: #1-#2



KA-1125 39pcs 3/8" Dr. Socket Set

14-3/8"dr.socket: 8-9-10-11-12-13-14-15-16-17-18-19-21-22mm
 6-3/8"dr.deep socket: 8-10-12-13-17-19mm
 1-3/8" dr. oval ratchet handle (quick release)
 2-Extension Bar: 3" & 6"
 1-Coupler 3/8"(F) x 1/4"(Hex)
 1-Universal Joint
 2-Spark Plug 16mm & 21mm
 1-TM-HEAD 3/8"M x 1/2"F
 11-Bits: Phillips: #1 - #2 & Pozidriv: #1 - #2 & Hex: 5-6mm
 Slotted: 4-5.5mm & Torx: T10-T15-T20



KA-1126 61pcs 3/8" Dr. Socket Wrench Set

2-3/8"dr.spark plug socket 16mm & 21mm
 2-3/8"dr.extension bar 75mm & 250mm
 1-TM-HEAD 3/8"M x 1/2"F
 1-3/8"dr.universal joint
 10-3/8"dr.deep socket: 8-9-10-11-12-13-14-15-17-19mm
 25-3/8"dr.bit socket:
 PH:1-2-3 & PZ: 1-2-3 & SL:5.5-7-8 & Hex: 3-4-5-7-8-10
 Torx: T15-T20-T25-T27-T30-T40-T45-T50-T55
 1-3/8"dr.socket adaptor
 1-3/8"dr.oval ratchet handle w/quick release
 18-3/8"dr.socket: 6-7-8-9-10-11-12-13-14-15-16-17-18-19-20-21-22-24mm



KA-1127 61pcs 3/8" Dr. Super Lock Socket Wrench Set

2-3/8"dr.spark plug socket 16mm & 21mm
 2-3/8"dr.extension bar 75mm & 250mm
 1-3/8"dr.TM-HEAD 3/8"M x 1/2"F
 1-3/8"dr.universal joint(spring)
 10-3/8"dr.deep socket: 8-9-10-11-12-13-14-15-17-19mm
 25-3/8"dr.bit socket:
 PH:1-2-3 & PZ: 1-2-3 & SL:5.5-7-8 & Hex: 3-4-5-7-8-10
 Torx: T15-T20-T25-T27-T30-T40-T45-T50-T55
 1-3/8"dr. adaptor
 1-3/8"dr.oval ratchet handle w/quick release (27T)
 18-3/8"dr.supper lock socket: 6-7-8-9-10-11-12-13-14-15-16-17-18-19-20-21-22-24mm



KA-1128 71pcs 3/8" Dr. Super Lock Socket Wrench Set

2-3/8"dr.spark plug socket 16mm & 21mm
 2-3/8"dr.extension bar 75mm & 250mm
 1-3/8"dr.universal joint(spring)
 10-3/8"dr.deep socket: 8-9-10-11-12-13-14-15-17-19mm
 25-3/8"dr.bit socket:
 PH:1-2-3 & PZ: 1-2-3 & SL:5.5-7-8 & Hex: 3-4-5-7-8-10
 Torx: T15-T20-T25-T27-T30-T40-T45-T50-T55
 1-3/8"dr. adaptor
 1-Bit Adaptor 3/8"dr. x 8mm
 1-3/8"dr.oval ratchet handle w/quick release
 18-3/8"dr.socket: 6-7-8-9-10-11-12-13-14-15-16-17-18-19-20-21-22-24mm
 9-Torx Bit: 8MM x 30L
 W/Temperproof: T15-T20-T25-T27-T30-T40-T45-T50-T55



KA-1129 23pcs 1/2" Dr. Super Lock Socket Wrench Set

18-Socket: 10-11-12-13-14-15-16-17-18-19-20-21-22-23-24-27-30-32mm
 1-Ratchet Handle Offset Type-72 Teeth(quick release)
 3-Extension Bar: 50-125-150mm
 1-Universal Joint W/Screw



KA-1130 24pcs 1/2" Dr. Socket Wrench Set

18-Socket: 10-11-12-13-14-15-16-17-18-19-20-21-22-23-24-27-30-32mm
 2-Extension Bar: 125mm & 250mm
 1-1/2"dr. T-handle
 1-Flexible Handle 15"
 1-Universal Joint
 1-Ratchet Handle



KA-1131 26pcs 1/2" Dr. Socket Wrench Set

18-Socket: 10-11-12-13-14-15-16-17-18-19-21-22-23-24-26-27-30-32mm
 2-Extension Bar 125mm & 250mm
 2-Spark Plug Socket 16mm & 21mm
 1-Sliding Bar 250mm
 1-Oval Ratchet Handle (quick release)
 1-Universal Joint
 1-Speeder Handle



KA-1132 17pcs 1/2" Dr. Socket Set

13-Socket: 9-10-11-12-13-14-15-16-17-19-21-24-27mm
 1-Oval Ratchet Handle (quick release)
 1-Flex Handle
 1-Extension Bar 5"
 1-Metal Case



3/4" Dr. 21pcs Socket Wrench Set

KA-2319K (mm size)

Contents :
 16PC - 6PT & 12PT Socket:
 19, 21, 22, 23, 24, 26, 27, 29, 30,
 32, 35, 36, 38, 41, 46, 50mm
 1PC - 500mm Ratchet Handle
 1PC - 450mm Sliding Bar
 2PC - 100 & 200mm Extension Bar

KA-2320K (inch size)

Contents :
 16PC - 6PT & 12PT Socket:
 7/8, 15/16, 1, 1-1/16, 1-1/8,
 1-3/16, 1-1/4, 1-5/16, 1-3/8,
 1-7/16, 1-1/2, 1-5/8, 1-3/4,
 1-13/16, 1-7/8, 2"
 1PC - 20 Ratchet Handle
 1PC - 18 Sliding Bar
 2PC - 4 & 8 Extension Bar



1" Dr. 22pcs Socket Wrench Set

KA-2322K (mm size)

Contents :
 17PC - 6PT & 12PT Socket:
 36, 38, 41, 46, 46, 50, 54, 55,
 58, 60, 63, 65, 67, 70, 71, 75,
 77mm
 1PC - Ratchet Head
 1PC - Sliding Head
 1PC - 22 Universal Handle
 2PC - Extension Bar & 8 & 16

KA-2323K (inch size)

Contents :
 17PC - 6PT & 12PT Socket:
 1-7/16, 1-1/2, 1-5/8, 1-11/16,
 1-3/4, 1-13/16, 1-7/8, 2, 2-1/8,
 2-3/16, 2-1/4, 2-3/8, 2-1/2,
 2-5/8, 2-3/4, 2-15/16, 3-1/8
 1PC - Ratchet Head
 1PC - Sliding Head
 1PC - 22 Universal Handle
 2PC - Extension Bar & 8 & 16



KA-1133 24pcs 1/2" Dr. Socket Set

18-Socket: 10-11-12-13-14-15-16-17-18-19-20-21-22-23-24-27-30-32mm
 1-Oval Ratchet Handle (quick release)
 1-Flex Handle
 2-Extension Bar 5" & 10"
 1-Universaal Joint
 1-Sliding Bar



KA-1134 25pcs 1/2" Dr. Socket Set

18-Socket: 8-9-10-11-12-13-14-17-18-19-20-21-22-23-24-26-30-32mm
 1-1/2" dr. oval type ratchet handle
 1-Sliding T-Handle 12"
 2-1/2"dr.extension bar 5" & 10"
 1-1/2"dr. universal joint
 1-1/2"dr. flex handle 15"
 1-Spark Plug 21mm



KA-2286K 56pcs 1/4" & 1/2" Drive Socket & Bit Set

12-1/4" Dr. Socket : 4, (4.5), 5, (5.5), 6, 7, 8, 9, 10, 11, 12, 13mm
 13-1/2" Dr. Socket : 10, 11, 12, 13, 14, 15, 17, 19, 22, 24, 27, 30, 32mm
 1-1/4" Dr. Quick Release Ratchet Handle
 1-1/4" Dr. Universal Joint
 1-1/4" Extension Bar 50mm
 5-Hex Key : (1.25), (1.5), 2, (2.5), 3mm
 2-1/2" Dr. Spark Plug Socket 16mm & 21mm
 1-1/2" Dr. Universal Joint
 1-1/2" Dr. Extension Bar 63mm
 1-1/2" Dr. Extension Bar 250mm
 1-3/8" (F) x 1/2" (M) T-Bar Adapter
 1-1/4" Dr. Spinner Handle
 1-1/4" Dr. Extension Bar 150mm
 1-3/8" (F) x 1/4" (M) T-Bar Adapter
 1-1/2" Dr. Quick Release Ratchet Handle
 2-1/4" Dr. Phillips Bit Socket : #1, #2
 2-1/4" Dr. Slotted Bit Socket : 4, (5.5)mm
 3-1/4" Dr. Hex Bit Socket : 4, 5, 6mm
 5-1/4" Dr. Torx Bit Socket : T-15, 20, 25, 27, 30
 1-Metal box



KA-1135 10pcs 1/2" Dr. Socket Set

10-11-12-14-16-17-19-21-22-24mm
 (3/8"-1/16"-1/2"-9/16"-5/8"-11/16"-3/4"-13/16"-7/8"-15/16")



KA-1136 21pcs 1/2" Dr. Socket Set

21pc 1/2"dr.socket set
 16-1/2"dr. socket (super lock):
 10-11-12-13-14-15-16-17-18-19-21-22-24-27-30-32mm
 1-1/2" dr. oval ratchet handle w/nylon grip & 45T
 2-1/2" dr. extension bar: 3" & 5"
 1-1/2" TM-HEAD (1/2"M x 3/8"F)
 1-1/2" dr. universal joint



KA-1137 22pcs 1/2" Dr. Socket Wrench Set

15-Socket 1/2" dr.: 10-11-12-13-14-15-16-17-18-19-22-24-27-30-32mm
 1-Oval Ratchet Handle W/Nylon Grip(quick release)
 1-TM-Head 1/2"M x 3/8"F
 2-Extension Bar 125mm & 250mm
 1-Universal Joint
 2-Spark Plug Socket 16 & 21mm



KA-1138 22pcs 1/2" Dr. Socket Set

2-1/2" dr. spark plug socket 16 & 21mm
 2-1/2" dr. extension bar 125 & 250mm
 1-TM-HE 1/2"M x 3/8"F
 1-1/2" dr. universal joint
 1-1/2" dr. oval ratchet handle (quick release)
 15-1/2" dr. sockets: 10-11-12-13-14-15-16-17-18-19-22-24-27-30-32mm



KA-1139 23pcs 1/2" Dr. Socket Wrench Set

15-Socket 1/2"dr. : 10-11-12-13-14-15-16-17-18-19-22-24-27-30-32mm
 1-Oval Ratchet Handle W/Nylon Grip(quick release)
 1-Metal Spin Disc
 2-Extension Bar 5" & 10"
 1-Universal Joint
 1-TM-HEAD 1/2"M x 3/8"F
 2-Spark Plug Socket 16mm & 21mm



KA-1140 24pcs 1/2" Dr. Socket Wrench Set

20-Socket: 8-9-10-11-12-13-14-15-16-17-18-19-20-21-22-23-24-27-30-32mm
 1-Oval Ratchet Handle W/Nylon Quick Release 24T W/Plastic Handle
 1-Metal Spin Disc
 2-Extension Bar125mm & 250mm



KA-1141 24pcs 1/2" Dr. Socket Wrench Set

18-Socket : 10-11-12-13-14-15-16-17-18-19-20-21-22-23-24-27-30-32mm
 1-Oval Ratchet Handle W/Nylon Quick Release 24T W/Plastic Handle
 1-Spark Plug Socket: 21mm
 1-Extension Bar 10"
 1-Universal Joint



KA-1142 27pcs 1/2" Dr. Socket Wrench Set

- 20-Socket : 8-9-10-11-12-13-14-15-16-17-18-19-20-21-22-23-24-27-30-32mm
- 1-Oval Ratchet Handle (quick release) W/72T
- 2-Extension Bar 5" & 10"
- 2-Spark Plug Socket 16mm & 21mm
- 1-TM-HEAD, 1/2"M x 3/8"F
- 1-Universal Joint



KA-1143 37pcs 1/4" & 1/2" Dr. Socket Wrench Set

- 11-1/4"dr.socket: 4-4.5-5-5.5-6-7-8-9-10-11-13mm
- 1-1/4"dr.ratchet handle w/quick release(oval)
- 1-1/4"dr.metal spin disc
- 1-1/4"dr.extension bar 50mm
- 1-1/4"dr.spinner handle
- 1-1/4"dr.sliding T bar
- 1-1/4"dr.universal joint
- 12-1/2"dr.ratchet handle w/quick release(oval)
- 1-1/2"dr.metal spin disc
- 1-1/2"dr.extension joint
- 1-1/2"dr.universal joint
- 1-1/2"dr.TM-HEAD 1/2"dr.(M) x 3/8"dr.(F)
- 2-1/2"dr.spark plug socket 16mm & 21mm



KA-1144 48pcs 1/4" & 1/2"Dr. Socket & Bit Socket Set

- 13-1/4"dr.socket: 4-4.5-5-5.5-6-7-8-9-10-11-12-13-14mm
- 18-1/2"dr.socket:10-11-12-13-14-15-16-17-18-19-20-21-22-23-24-27-30-32mm
- 2-1/4"dr. + 1/2"dr.: Oval Ratchet Handle (quick release)
- 1-1/4"dr.spinner handle
- 1-1/4"dr.slicing bar
- 2-1/4" + 1/2" :Universal Joint
- 2-1/4"dr.extension bar 2" & 4"
- 2-1/2"dr.spark plug socket 16mm & 21mm
- 2-1/2"dr.extension bar 5" & 10"
- 1-1/2"dr. T-M HEAD 1/2"M x 3/8"F
- 3-Hex Key Wrench 1.5-2-2.5mm
- 1-Flex. Ext Bar 150mm



KA-1145 72pcs 1/4" & 1/2" Dr. Socket Set

- 10-1/4"dr.socket: 4-5-5.5-6-7-9-10-11-12-13m/m
- 1-1/4"dr.oval ratchet handle (quick release)
- 1-Extension Bar: 100mm(L)
- 1-Spinner Handle
- 1-Coupler
- 16-1/2"dr.socket: 10-11-12-13-14-15-16-17-18-19-20-21-22-23-24-27mm
- 1-1/2" Oval Ratchet Handle (quick release)
- 2-Extension Bar: 125mm & 250mm
- 1-Spark Plug 21mm
- 1-Universal Joint
- 1-TM-HEAD 1/2"M x 3/8"F
- 33-Bits: PH: 0-1-2-3 & PZ: 1-2-3 & SL: 4-5-5-7 & TX: 8-10-15-20-25-27-30-40
- Hex: 7/32-1/4-5/16-5/32-1/8-3-32-5/64-2-2.5-3-4-5-6-8-10mm
- 3-Hex Key Wrench: 1.5-2-2.5mm



KA-1146 94pcs 1/4" & 1/2" Dr. Socket & Bit Socket Set

- 13-1/4"dr.socket: 4-4.5-5-5.5-6-7-8-9-10-11-12-13-14mm
- 8-1/4"dr.deep socket: 6-7-8-9-10-11-12-13mm
- 1-1/4"dr.double-end spinner handle 6"
- 2-1/4"dr.extension bar 2" & 4"
- 1-1/4"dr.oval ratchet handle (quick release)
- 1-1/4"dr.flex. extension bar 150 mm
- 1-1/4"dr.sliding T bar
- 1-1/4"dr.universal joint
- 1-socket adaptor 1/4" x 37L
- 17-Bits Socket: 1/4" x 37L
- SL: 4-5.5-7 & HEX: 3-4-5-6 & PH: 1-2 & PZ: 1-2 & TX: 8-T10-T15-T20-T25-T30
- 18-1/2"dr.socket: 10-11-12-13-14-15-16-17-18-19-20-21-22-23-24-27-30-32mm
- 4-1/2"dr.deep socket: 14-15-17-19mm
- 1-1/2"dr.oval ratchet handle (quick release)
- 2-1/2"dr.spark plug socket 16mm & 21mm
- 2-1/2"dr.extension bar 5" & 10"
- 1-1/2"dr.universal joint
- 1-TM-HEAD 1/2"M x 3/8"F
- 1-Bit Adaptor 1/2" x 8mm
- 3-Hex Key Wrench 1.5-2-2.5mm
- 15-Bits: 5/16" x 30L
- SL: 8-10-12 & PH: 3-4 & PZ:3-4 & HEX: 8-10-12-14 & TX:40-45-50-55



KA-1147 108pcs 1/4" & 1/2" Dr. Socket Wrench Set

- 13-1/4"dr.socket: 4-4.5-5-5.5-6-7-8-9-10-11-12-13-14mm
- 8-1/4"dr.deep socket: 6-7-8-9-10-11-12-13mm
- 5-1/4"dr.star socket: E4-E5-E6-E7-E8
- 2-1/4"dr.extension bar 50mm & 100mm
- 1-1/4"dr.spinner handle
- 1-1/4"dr.universal joint
- 1-1/4"dr.sliding T bar
- 1-1/4"dr.oval ratchet handle (quick release)
- 1-socket adaptor 1/4" x 37L
- 18-1/4"dr. bits Socket:
- HEX: 3-4-5-6 & SL: 4-5.5-6.5 & PH: 1-2 & PZ: 1-2 & TX: 8-10-15-20-25-27-30
- 17-1/2"dr.socket: 10-11-12-13-14-15-16-17-18-19-20-21-22-23-24-27-30-32mm
- 5-1/2"dr.deep socket: 14-15-17-19-22mm
- 8-1/2"dr.star socket: E10-E11-E12-E14-E16-E18-E20-E24
- 1-1/2"dr.oval ratchet handle (quick release)
- 2-1/2"dr.spark plug socket 16mm & 21mm
- 2-1/2"dr.extension bar : 125mm & 250mm
- 1-1/2"dr.universal joint
- 1-TM-HEAD 1/2"M x 3/8"F
- 1-1/2"dr. x 5/16" Coupler
- 17-Bits: 5/16" x 30L
- SL: 8-10-12 & PH: 3-4 & PZ:3-4 & HEX: 7-8-10-12-14 & TX:40-45-50-55-60
- 3-Hex Key Wrench 1.5-2-2.5mm



KA-1167 72pcs TX Socket & E-Type Wrench Tool Set

- 7-1/4"dr. E-Type socket: E4-E5-E6-E7-E8-E10-E11
- 7-1/2"dr. Socket: E12-E14-E16-E18-E20-E22-E24
- 6-1/4"dr. Torx bit socket: T10-T15-T20-T25-T27-T30
- 6-Torx bit: 10mm x 30(L)(tamperproof): 40-45-50-55-60-70
- 9-Torx bit: 10mm x 75(L): 15-20-25-30-40-45-50-55-60
- 3-Torx bit: 1/4" x 25(L)(W/O tamperproof): T7-T8-T9
- 7-Torx bit : 1/4" x 25(L)(W/O tamperproof): T10-T15-T20-T25-T27-T30-T40
- 12-TX Allen Key Wrenches(double end): T8-T10-T15-T20-T25-T27-T30-T40-T45-T50-T55-T60
- 8-Torx Screwdriver: T8-T10-T15-T20-T25-T27-T30-T40
- 4-Double Ring E-Type Wrench: E6xE8, E10xE12, E14xE18, E20xE24
- 2-Bit Holder: 1/4"dr.(F)x1/4"Hex(F) & 1/2"dr.(F)x100mm(F)
- 1-Magnetic Pick-up TOOL (fine needle: 0.6mm OR thick needle: 1.3mm)



KA-1148 10pcs 1/2" Deep Socket Set
 ■ 10-Deep Socket: 10-11-12-13-14-15-16-17-18-19mm



KA-1149 13pcs 1/4" Deep Socket Set
 ■ 13-Deep Socket: 4-4.5-5-5.5-6-7-8-9-10-11-12-13-14mm



KA-1150 14pcs 3/8" Deep Socket Set
 ■ 14-Deep Socket: 6-7-8-9-10-11-12-13-14-15-16-17-18-19mm



KA-1151 11pcs 1/4" Deep Socket Set
 ■ 11-Deep Socket: 4-5-5.5-6-7-8-9-10-11-12-13mm



KA-1152 15pcs 1/4" Deep Socket Set
 11-1/4"DR. Deep Socket: 4-5-5.5-6-7-8-9-10-11-12-13mm
 2-Extension Bar: 2" & 4"
 1-Sliding T-Bar
 1-Universal Joint



KA-1153 11pcs 1/2" Deep Socket Set
 ■ 11-Deep Socket: 8-10-11-12-13-14-15-16-17-18-19mm



KA-1154 8pcs 1/2"Dr. Torx Bit Socket Set
 ■ 8-Bit Socket: T27-T30-T40-T45-T50-T55-T60-T70



KA-1155 8pcs 1/2" Dr. Hex Bit Socket Set
 ■ 8-Bit Socket: 4-5-6-10-12-14-17mm



KA-1156 11pcs 1/2" Dr. Hex Bit Socket Set

- 11-Bit Socket: 4-5-6-7-8-9-10-12-14-17-19mm



KA-1157 4pcs 1/2" Dr. Torx Bit Socket Set

4-1/2"Dr. x 110mm(L): T70H-T80H-T90H-T100H

Socket: CR-V steel, Hardened & Sandblasted Mat Plated

Bit: CR-V steel, Hardened & Sandblasted



KA-2295K 7pcs 3/8" & 1/2" Drive Bit Socket Set

6-1/4" Dr. Torx Bit Socket 36mm : T-8, 10, 15, 20, 25, 27

6-1/2" Dr. Torx. Bit Socket 55mm : T-30, 40, 45, 50, 55, 60

6-1/2" Dr. Torx Bit socket 100mm : T-30, 40, 45, 50, 55, 60

1-Metal Box



KA-2295K 7pcs 3/8" & 1/2" Drive Bit Socket Set

4-3/8" Dr. Ribe Bit Socket 90mm : M6, M7, M8, M10

3-1/2" Dr. Ribe Bit Socket 100mm : M12, M13, M14



KA-1158 22pcs 1/2" Dr. Socket Bit & Star Key Wrench Set

9-Star Key Wrench: T10-T15-T20-T27-T30-T40-T45-T50

8-Star Socket Bit (55m/m): T20-T25-T30-T40-T50-T55-T60

2-Spline Socket Bit (55m/m): M5-M6

2-Spline Socket Bit (100m/m): M8-M10

1-Spline Socket Bit (120m/m): M12



KA-1159 28pcs 1/4" Dr. Socket Wrench & Bit Set

9-1/4"dr. socket: 5-6-7-8-9-10-11-12-13mm
 1-1/4"dr.72T Stubbt Oval ratchet handle quick release
 1-1/4" x 50mm Extension Bar
 1-Bit Adaptor 1/4"SQ. x 1/4"dr.(F)
 1-61/4"dr. Bit 25mm(L)
 PH: 1-2 & PZ: 1-2 & HEX: 3-4-5-6 & SL: 4.5-6 & TX: 15-20-25-27-30-40



KA-1160 46pcs 1/4" Dr. Socket Wrench & Bit Set

12-1/4"dr.socket: 4-4.5-5-5.5-6-7-8-9-10-11-12-13mm
 3-1/4"dr. wobble extension bar: 50mm & 100mm & 150mm
 1-1/4"dr. spinner handle
 1-1/4"dr. universal joint
 1-Bit Adaptor 1/4"sq. x 1/4"dr. (F)
 1-1/4"dr. 24T oval ratchet handle w/quick release
 24-1/4"dr. bit 25mm(L):
 HEX: 3-4-5-6-7 & SL: 3-4-5-6 & PH: 0-1-2-3 & PZ: 0-1-2 &
 TORX(tamperproof): T10H-T15H-T20H-T25H-T27H-T30H-T40H
 3-Hex Key Wrench: 1.5-2-2.5mm



KA-1161 47pcs Ratchet S/D Bit & Socket Set

1-Magnetic Bit Holder
 3-Ratchet S/D
 9-1/4" dr. socket (CR-V): 5-6-7-8-9-10-11-12-13 W/Plastic Holder
 36-25mm(L) Bit (S2):
 PZ: 1-2-3 & PH: 3 (W/Plastic Holder)
 SL: 3-4-5-6-7mm (W/Plastic Holder)
 TORX: T10-T15-T20-T25-T27-T30-T40 (W/Plastic Holder)
 HEX: 2-2.5-3-4-5-6-7-8 & Adaptor (W/Plastic Holder)
 PHILLIPS: #1x#3, #2x #6, #3x#2 (W/Plastic Holder)



KA-1162 9pcs 1/2"Dr. E-Type Socket Set

■ 9-1/2"dr.E-Type socket: E10-E11-E12-E14-E16-E18-E20-E22-E24

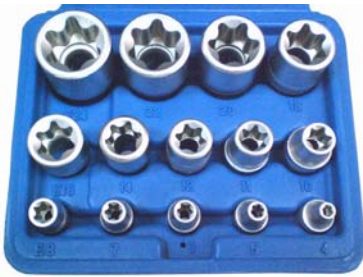

KA-1163 14pcs 1/4" & 3/8" & 1/2"Dr. E-Type Socket Set

5-1/4"dr.E-Type socket: E4-E5-E6-E7-E8
 5-3/8"dr.E-Type socket: E10-E11-E12-E14-E16
 4-1/2"dr.E-Type socket: E18-E20-E22-E24



KA-1164 17pcs 1/4" & 3/8"Dr. "E" Socket & Torx Bit Set

3-1/4"dr."E" socket: E6-E7-E8
 4-3/8"dr."E" socket: E10-E12-E14-E16
 9-Torx Bit (8mm x 30L) W/Tamperproof: 10-15-20-25-30-40-45-50-55
 1-Adaptor: 3/8"dr. x 8mm



KA-1165 16pcs 1/2"Dr. "E" Socket & Torx Bit Set

9-1/2"dr."E" socket: E10-E11-E12-E14-E16-E18-E20-E22-E24
 7-1/2"dr.star socket bit (55L): T30-T40-T45-T50-T55-T60-T70



KA-1166 19pcs 1/2"Dr. "E" Socket & Torx Bit Set

9-1/2"dr."E" socket: E10-E11-E12-E14-E16-E18-E20-E22-E24
 10-1/2"dr.star bit socket bit (55L): 20-25-27-30-40-45-50-55-60-70



KA-1168 27pcs S/D Bit & Drill Set

20-25mm Bit: Torx: T10-T15-T20-T25-T27-T30-T40-T45 & SL: 4-7
 Hex: 3-4-5-6 & PH: 1-2-3 & PZ: 1-2-3
 1-Quick Chuck
 5-Drill and Bit Drill:
 PH: #1x2.5mm(1pc) & #2x3mm (2pcs) & #3x4mm (2pcs)
 1- 60mm Magnetic Bit Holder



KA-1169 33pcs Ratchet S/D Bit & Drill Set

- 1-Ratchet S/D
 - 1-Disc
 - 6-50mm Bit: Phillips: #1-#2 & Torx: T15-T20 & Slotted: 4, 7mm
 - 7-1/4" Socket: 6,7,8,9,10,11,12m/m
 - 1-50mm Socket Adaptor
 - 1-60mm Magnetic Bit Holder
 - 14-25mm Bit:
 - PH: 1-2-3 & SL: 4-7 & TX: T15-T20-T30 & Hex: 2-3-4-5-6 & Socket Adaptor
 - 2-Precision S/D: Phillips & Slotter
-



KA-1170 34pcs S/D Bit & Drill & Socket Set

- 1-Finder Driver Bit
 - 15-25mm Bit: PH: 1-2-3 & PZ: 1-2-3 & TX: T15-T20-T30 & Hex: 4-5-6 & SL: 4-6-7
 - 7-1/4" Socket: 5,6,7,8,9,10,11m/m
 - 4-50mm Bit: Phillips: #1, #2 & Slotted: 4,7mm
 - 5-Bit Drill: PH: #1x2.5mm (2pcs) & #2x3mm (2pcs) & #3x4mm (1pcs)
 - 1-60mm Magnetic Bit Holder
 - 1-Quick Chuck
-



KA-1171 48pcs Ratchet S/D Bit & Drill Set

- 1-Ratchet S/D
 - 1-Disc
 - 26-25mm Tamperproof Bit:
 - Torx(tamper): T8H-T10H-T15H-T20H-T24H-T25H-T27H-T30H-T35H-T40H & Hex: 2.5-3-4-6 & Torg: 6-8-10 & 4-Tri-Wing: 1-2-3-4 & Spanner: 4-6-8-10
 - 7-25mm Bit: PH: 0-1-2-3 & Socket Adaptor
 - 10-1/4" Socket: 4-4.5-5-6-7-8-9-10-11-12m/m
 - 1-60mm Magnetic Bit Holder
 - 1-Eyelet Bit & 1-Counter Sink
-



KA-1172 32pcs Double Ways Ratchet S/D Bit & Nut Driver Set

- 1-Mini Double Ways Ratchet S/D
 - 26-Bit: 1/4" x 25L
 - PH: #1-#2-#3 & PZ: #1-#2 & SL: 3-4-5-6-7 & Adaptor
 - HEX: 1.5-2-2.5-3-4-5-5.5-6 & TORX: 10-15-20-25-27-30-40
 - 5-Nut Driver : 5-5.5-6-7-8
-



KA-1173 32pcs Double Ways Ratchet S/D & Tamperproof Bit Set

- 1-Mini Double Ways Ratchet S/D
 - 26-Bit: 1/4" x 25L
 - (w/tamer) TORX: 8-10-15-20-25-30-35-40 & Hex: 2-2.5-3-4-5-6
 - Spanner: 4-6-8-10 & Tri Wing: 1-2-3-4 & Torq: 6-8-10
 - 5-Bit: Phillips: #1-#2 & Slotted: 4-7mm & Adaptor
-



KA-1174 33pcs Security Bits Set

1-60mm Magnetic Bit Holder
 32-Bit 1/4"x25L:
 Torq: 6-8-10 & Spanner: 4-6-8-10 & Tri-Wing : 1-2-3-4
 Tamper Hex: 2-2.5-3-4-5-6-5/32"-9/64"-1/8"-7/64"-3/32"-5/64"
 Torx (W/Tamper) : T8-T10-T15T-20-T25-T27-T30-T35-T40



KA-1175 36pcs Bits Set

1-60mm Magnetic Bit Holder(Aluminum)
 1-1/4" x 1/4" Socket Adaptor
 32-Bit 1/4"x25L:
 SL: 4-4.5-5.5 & Hex: 3-4-5-6 & PH: #1-#2-#3 & PZ: # x2, #2x2, #3x2
 Torx(Tamper): 10-15-20-25-27-30 &
 Torx: 10-15-20-20-25-25-27-27-30-30-40-40



KA-1176 50pcs Bits Set

1-60mm Magnetic Bit Holder
 49-75mm Bits:
 SL: 4-5-6 & PH: #1-#2 & PZ: #1-#2 & Hex: 4-5-6
 Hex(Tamper): 2-2.5-3-4-5-6 & Torx(Tamper): 8-10-15-20-25-27-30-35-40
 Torx:10-15-20-25-30 & Spline:5-6-8 & Spanner:4-6-8-10 &
 Torq: 6-8-10 & Tri Wing: 1-2-3-4 & Butterfly: 1-2-3



KA-1177 99pcs Ratchet Handle & Bit Set

1-60mm Magnetic Bit Holder
 1-1/4" x 1/4" Spinner Handler & 1-1/4" x 1/4" Adaptor
 79-25mm Bits:
 9-SL: 3-4-4.5-5-5.5-6-6.5-7-8 & 5-PH: 0-1-2-2-3 & 5-PZ: 0-1-2-2-3
 9-Hex:1.5-2-2.5-3-4-5-5.5-6-8 & 9-Torx: 8-10-15-20-25-27-30-40-45
 12-Hex(Tamper): 2-2.5-3-4-5-6mm, 5/64",3/32",7/64",1/8",9/64",5/32"
 9-Torx (Tamper): 8-10-15-20-25-27-30-35-40
 3-Spline: M5-M6-M8 & 4-Spnee: 4-6-8-10 & 3-Torq: 6-8-10
 4-Tri Wing: 1-2-3-4 & 3-Butterfly: 1-2-3 & 4-Square: 0-1-2-3
 17-75mm Bits:
 3-Torq: 6-8-10 & 4-Tri Wing: 1-2-3-4 & 4-Spanner: 4-6-8-10
 3-Hex(Tamper): 4-5-6mm & 3-Torx (Tamper): T15H-T20H-T30H



KA-1178 100pcs Bits Set

1-60mm Magnetic Bit Holder
 1-Special Hook Driver Bit(Adaptor)
 1-1/4" Extension Socket Adaptor(50mm)
 1-1/4" x 1/4" Bit Adaptor
 1-1/4" x 1/4" Socket Adaptor(25mm)
 95-Bits:
 9-SL: 3-4-4.5-5-5.5-6-6.5-7-8 & 8-PH: 0-1-2-2-2-2-3 & 8-PZ: 0-1-2-2-2-2-3
 10-Hex (inch): 1/16"-5/64"-3/32"-7/64"-1/8"-9/64"-5/32"-3/16"-7/32"-1/4"
 9-Hex (metric): 1.5-2-2.5-3-4-5-5.5-6-8
 9-TX: 8-10-15-20-25-27-30-40-45 & 9-TX(Tamper): 8-10-15-20-25-27-30-35-40
 12-Tamper Hex (metric): 2-2.5-3-4-5-6 & (inch):
 5/32"-9/64"-1/8"-7/64"-3/32"-5/64"
 3-Spline: 5-6-8 & 4-Spnee: 4-6-8-10 & 3-Torq: 6-8-10
 4-Tri Wing: 1-2-3-4 & 3-Butterfly: #1-#2-#3 & 4-Square: #0-#1-#2-#3



KA-1180 11pcs Power Bit Set

5- SPLINE BITS, 30MM EACH OF: M5-M6-M8-M10-M12
 5- SPLINE BITS, 75MM EACH OF: M5-M6-M8-M10-M12
 1- BIT ADAPTER: 1/2" X 10 mm



KA-1306 17pcs 1/2" Dr. Ribe Tip Power bit Set

5- SPLINE BITS, 30MM EACH OF: M5-M6-M7-M8-M10
 5- SPLINE BITS, 75MM EACH OF: M5-M6-M7-M8-M10-M11-M12-M13-M14
 1- BIT ADAPTER: 1/2" X 10 mm



KA-1181 21pcs Ribe Power Bit Set

9-40mm(L): M5-M6-M7-M8-M9-M10-M11-M12-M13
 10-75mm(L): M5-M6-M7-M8-M9-M10-M11-M12-M13-M14
 2-Bit Adaptor: 3/8" dr.x10mm & 1/2" dr.x10mm



KA-1182 40pcs Power Bit Set

14-HEX KEY BITS, 30MM & 75MM EACH OF: 4-5-6-7-8-10-12 MM
 14-Torx BITS, 30MM & 75MM EACH OF: T20-T25-T30-T40-T45-T50-T55
 10-SPLINE BITS, 30MM & 75MM EACH OF: M5-M6-M8-M10-M12
 2-BIT ADAPTER: 1/2". & 3/8" x 10mm



KA-1183 14pcs Ribe Power Bit Set

6-40MM(L):M5-M6-M7-M8-M10-M12
 7-75MM(L):M7-M8-M9-M10-M12-M13-M14
 1-BIT ADAPTOR 1/2"Dr. x 10mm



KA-1184 46pcs Power Bit Set With 10mm Hex Shank

29-BITS(30m/mL)
 Hex: 4-5-6-7-8-10-12-14 & PH: 1-2-3 & SL: 8-10 &
 Spline: M5-6-8-10-12 &
 Torx(Tamperproof): T10-15-20-25-27-30-40-45-50-55-60
 15-BITS(75m/m)
 HEX:5-6-7-8-10 & Spline: M6-8-10-12 & TX: T25-30-40-45-50-55
 2-BIT ADAPTOR 3/8" & 1/2" DR. x 10mm



KA-1185 36pcs Ratchet Handle & 10mm Power Bit Set

1-OVAL RATCHET HANDLE
 2-BIT ADAPTOR: 3/8" x 10mm & 1/2" x 10mm
 21-10mm x 30(L) BIT: HEX: 5-6-7-8-10-12 & SPLINE: 5-6-8-10-12
 TORX: 20-25-30-40-45-50-55-60 & PH: 2-3
 12-10mm x 75(L) BIT: TX :20-25-30-40-45-50-55-60 & SPLINE: 6-8-10-12



KA-1186 57pcs Power Bit & Star Socket Set

18-10mm x 75(L) BIT:
 HEX: 5-6-7-8-10 & SPLINE: 6-8-10-12 & TX: T20-25-27-30-40-45-50-55-60
 25-10mm x 30(L) BIT: TX(TAMPER):20-25-27-30-40-45-50-55-60 &
 HEX: 4-5-6-7-8-10-12 & SPLINE: 5-6-8-10-12 & PH: 2-3 & SL: 8-10
 2-BIT ADAPTOR: 1/2" x 10mm & 3/8" x 10mm
 5-1/4"Dr.STAR SOCKET:E4-E5-E6-E7-E8
 4-3/8"Dr.STAR SOCKET:E10-E11-E12-E14
 3-1/2"Dr.STAR SOCKET:E16-E18-E20



KA-1187 30pcs Screwdriver & Bit Set

1-Screwdrive Tri Tone Color + Quick Release Holder
 1-60mm Magnetic Bit Holder , Stainless
 3-25mm Pozidrive: #1,2,3
 3-25mm Phillips: #0,1,2,
 5-25mm Slotted: 3mm.4mm.5mm.6mm.8mm
 6-25mm Hex: (tamperproof) 2mm-2.5mm-3mm-4mm-5mm-6mm
 11-Star (tamperproof): T5-T6-T7-T8-T9-T10- T15-T20-T25-T30-T40



KA-1257 35pcs Torx Socket & Bit Set

5-1/4"Dr. "E" Socket: E4-E5-E14-E6-E7-E8
 6-3/8"Dr. "E" Socket: E10-E12-E14-E16-E18-E20
 5-Torx Bit 1/4" x 30mm: T8-T9-T10-T15-T20
 6-Torx Bit 10mm x 30mm: T25-T27-T30-T40-T45-T50
 6-Torx Bit 10mm x 75mm: T25-T27-T30-T40-T45-T50
 3-Torx Bit 14mm x 75mm: T55-T60-T70
 4-Bit Holder: 1/4"Dr. x 6mm & 3/8"Dr. x 10mm
 1/2"Dr. x 10mm & 1/2"Dr. x 14mm



KA-1619N Torx Wrench Set (L)

- 7pc: M4-M5-M6-M7-M8-M9-M10



KA-1629N Torx Wrench Set (L)

(two side with hold)

- 9pc:T10-T15-T20-T25-T27-T30-T40-T45-T50



KA-3629N

Ball Point Hex Key Wrench Set

- 9pc: 1.5-2-2.5-3-4-5-6-8-10mm



KA-1138N Torx Wrench Set

(with hole)

- 7pc: T8, T10, T15, T20, T25, T27, T30



KA-0137N Hex Key Wrench Set

- 7pc: 2-2.5-3-4-5-6-8mm



KA-0117N Hex Key Wrench Set

- 7pc: 2.5-3-4-5-6
- ⊕2 ~ Ø5



KA-7359A T-Handle Hex Socket Wrench Set
 SIZE: 8-10-13mm
 (CR-V STEEL, HARDENED & SATIN CHROME PLATED)

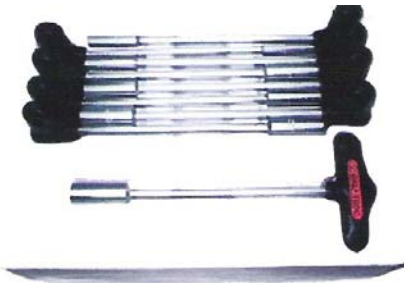

KA-1188 9pcs T-Handle Hex Socket Wrench Set
 SIZE: 6-7-8-9-10-11-12-13-14 MM × 230MM(L)
 (CR-V STEEL, HARDENED & SATIN CHROME PLATED)
 ALL IN PLASTIC TRAY



KA-4176K 10pcs T-Handle Nut Drive 2/TO Approve Replace
 1-SLIDING T BAR 200MM
 9PC-NUT DRIVER 295MM
 8-9-10-11-12-13-14-17-19 MM
 PACKING: W/VINLY POUCH+COLOR BOX + SHRINK



KA-1189 6pcs Adaptor Set
 1-1/4"(M) × 3/8"(F) ADAPTOR 1-3/8"(M) × 1/4"(F) ADAPTOR
 1-1/2"(M) × 3/8"(F) ADAPTOR 1-3/8"(M) × 1/2"(F) ADAPTOR
 1-3/4"(M) × 1/2"(F) ADAPTOR 1-1/2"(M) × 3/4"(F) ADAPTOR



KA-1190 9pcs 1/4" & 3/8" & 1/2" Dr. Wobble Extension Bar Set
 3-1/4DR. WOBBLE EXTENSION BAR: 50MM & 100MM & 225MM
 3-3/8DR. WOBBLE EXTENSION BAR: 75MM & 150MM & 225MM
 3-1/2DR. WOBBLE EXTENSION BAR: 50MM & 125MM & 250MM



KA-1195 6pcs 1/2"Dr. Deep Star Socket Set
 6-1/2"dr.deep extra deep : 150mm
 E10-E12-E14-E16-E18-E20



KA-1179 101pcs Ratchet Handle & Bits Set

1-60mm Magnetic Bit Holder & 1-1/4" dr. Tatchet Handle
 1-1/4" x 1/4" Spinner Handler & 1-1/4" x 1/4" Adaptor
 79-25mm Bits:
 9-SL: 3-4-4.5-5-5.5-6-6.5-7-8 & 5-PH: 0-1-2-2-3 & 5-PZ: 0-1-2-2-3
 9-Hex: 1.5-2-2.5-3-4-5-5.5-6-8 & 9-Torx: 8-10-15-20-25-27-30-40-45
 12-Hex(Tamper): 2-2.5-3-4-5-6mm, 5/64", 3/32", 7/64", 1/8", 9/64", 5/32"
 9-Torx (Tamper): 8-10-15-20-25-27-30-35-40
 3-Spline: M5-M6-M8 & 4-Spnee: 4-6-8-10 & 3-Torq: 6-8-10
 4-Tri Wing: 1-2-3-4 & 3-Butterfly: 1-2-3 & 4-Square: 0-1-2-3
 17-75mm Bits:
 3-Torq : 6-8-10 & 4-Tri Wing: 1-2-3-4 & 4-Spanner: 4-6-8-10
 3-Hex(Tamper): 4-5-6mm & 3-Torx (Tamper): T15H-T20H-T30H



(PAT.NO: M310794)

KA-1191 108pcs 1/4" & 1/2" Socket Wrench Set

13-1/4"Dr.SOCKET W/SUPER LOCK:
 4-4.5-5-5.5-6-7-8-9-10-11-12-13-14
 8-1/4"Dr.DEEP SOCKET W/SUPER LOCK: 6-7-8-9-10-11-12-13 mm
 5-1/4"Dr. "E" SOCKET: E4-E5-E6-E7-E8
 2-1/4"Dr.EXTENSION BAR: 50mm & 100mm
 1-1/4"Dr.SPINNER HANDLE
 1-1/4"Dr.UNIVERSAL JOINT
 1-1/4"Dr.SLIDING T-BAR
 1-1/4"DR. OVAL RATCHET HANDLE (QUICK RELEASE) W/72T
 18-1/4"Dr.BIT SOCKET:
 HEX: 3-4-5-6mm & SLOTTDE: 4-5.5-7mm
 PHILLIPS: #1-#2 & POZIDRIV: #1-#2
 TORX: T8-T10-T15-T20-T25-T27-T30
 17-1/2"Dr.SOCKET W/SUPER LOCK :
 10-11-12-13-14-15-16-17-18-19-20-21-22-24-27-30-32
 5-1/2"Dr.DEEP SOCKET W/ SUPER LOCK: 14-15-17-19-22 mm
 8-1/2"Dr. " E"SOCKET: E10-E11-E12-E14-E16-E18-E20-E24
 1-1/2"DR. OVAL RATCHET HANDLE (QUICK RELEASE) W/ 72T
 2-1/2"Dr.EXTENSION BAR: 5" & 10"
 2-1/2"Dr.SPARK PLUG SOCKET :16mm & 21mm
 1-1/2"Dr.UNIVERSAL JOINT
 1-1/2"DR. TM - HEAD 1/2"M X 3/8"F
 1-1/2"Dr. x 5/16" BIT ADAPTOR
 17-5/16" x 30L BIT:
 SLOTTED: 8-10-12 mm & PHILLIPS: #3-#4
 POZIDRIV: #3-#4 & HEX: 7-8-10-12-14 mm
 TORX: T40-T45-T50-T55-T60
 3-HEX KEY WRENCH: 1.5-2-2.5mm



(PAT.NO: M310794)

KA-1192 115pcs 1/4" & 1/2" Spline Socket Set

13-1/4"Dr.SPLINE SOCKET: 4-4.5-5-5.5-6-7-8-9-10-11-12-13-14 mm
 8-1/4"Dr.DEEP SPLINE SOCKET: 6-7-8-9-10-11-12-13 mm
 2-1/4"Dr.EXTENSION BAR: 2" & 4"
 1-1/4"DR. OVAL RATCHET HANDLE (QUICK RELEASE) W/72T
 1-1/4"Dr.SPINNER HANDLE
 1-1/4"Dr.UNIVERSAL JOINT
 1-1/4"Dr.SLIDING T- BAR
 1-1/4"Dr. X 1/4" BIT ADAPTOR
 17-1/4"Dr.BIT SOCKET:
 HEX: 3-4-5-6mm & SLOTTDE: 4-5.5-7mm
 PHILLIPS: #1-#2 & POZIDRIV: #1-#2
 TORX: T8-T10-T15-T20-T25-T30
 20-1/4"Dr.X 25L BIT W/PLASTIC HOLDER :
 SPLINE: M5-M6-M8 & RIBE: RM5-RM6-RM7-RM8-RM9
 TORX: T5-T6-T7 & TORX(W/TAMPER): T7
 FIVE STAR: TS10-TS15-TS20-TS25-TS27-TS30-TS40-TS45
 18-1/2"Dr.SPLINE SOCKET:
 10-11-12-13-14-15-16-17-18-19-20-21-22-23-24-27-30-32
 4-1/2"Dr.DEEP SPLINE SOCKET: 14-15-17-19 mm
 1-1/2"DR. OVAL RATCHET HANDLE (QUICK RELEASE) W/ 72T
 2-1/2"Dr.EXTENSION BAR: 5" & 10"
 2-1/2"Dr.SPARK PLUG SOCKET: 16mm & 21mm
 1-1/2"Dr.UNIVERSAL JOINT
 1-1/2"DR. TM - HEAD 1/2"M X 3/8"F
 1-1/2"Dr. X 5/16" BIT ADAPTOR
 15-5/16" x 30L BIT: SLOTTED :8-10-12 mm & PHILLIPS :#3-#4
 & POZIDRIV: #3-#4 & HEX: 8-10-12-14 mm
 & TORX:T40-T45-T50-T55
 1-1/4"Dr. x 30L SOCKET ADAPTOR
 4-HEX KEY WRENCH : 1.27-1.5-2-2.5mm



(PAT.NO: M310794)

KA-1193

171pcs 1/4" & 3/8" & 1/2" Spline Socket Set

- 13-1/4"Dr.SPLINE SOCKET: 4-4.5-5-5.5-6-7-8-9-10-11-12-13-14 mm
- 7-1/4"Dr.DEEP SPLINE SOCKET: 4-5-6-7-8-9-10 mm
- 5-1/4"Dr. "E" SOCKET: E4-E5-E6-E7-E8
- 2-1/4"Dr.EXTENSION BAR: 2" & 4"
- 1-1/4"DR. OVAL RATCHET HANDLE (QUICK RELEASE) W/72T
- 1-1/4"Dr.SPINNER HANDLE
- 1-1/4"Dr.UNIVERSAL JOINT
- 1-1/4"Dr.SLIDING T-BAR
- 30-1/4"Dr.BIT SOCKET:
 - HEX: 3-4-5-6mm & SLOTTDE: 4-5.5-6.5-7mm
 - PHILLIPS: #0-#1-#2 & POZIDRIV: #0-#1-#2 &
 - TORX: T8-T9-T10-T15-T20-T25-T27-T30
 - TORX(W/TAMPER): TH8-TH9-TH10-TH15-TH20-TH25-TH27-TH30
- 20-1/4"Dr.X 25L BIT W/PLASTIC HOLDER :
 - SPLINE: M5-M6-M8 & RIBE: RM5-RM6-RM7-RM8-RM9
 - TORX: T5-T6-T7 & TORX(W/TAMPER): T7
 - FIVE STAR: TS10-TS15-TS20-TS25-TS27-TS30-TS40-TS45
- 1-1/4"SQ X 1/4" HEX BIT ADAPTOR
- 10-3/8"Dr.SPLINE SOCKET: 10-11-12-13-14-15-16-17-18-19 m/m
- 6-3/8"Dr.DEEP SPLINE SOCKET: 10-11-12-13-14-15 mm
- 6-3/8"Dr. "E" SOCKET : E10-E11-E12-E14-E16-E18
- 1-3/8"DR. OVAL RATCHET HANDLE (QUICK RELEASE) W/72T
- 1-3/8"Dr.EXTENSION BAR: 5"
- 1-3/8"Dr.UNIVERSAL JOINT
- 1-3/8"Dr.SPARK PLUG 18mm
- 1-3/8"Dr.SQ X 5/16" HEX BIT ADAPTOR
- 24-5/16" x 30L BIT:
 - SLOTTED: 8-10-12 mm & PHILLIPS: #3-#4 & POZIDRIV: #3-#4
 - HEX: 7-8-10-12-14 mm & TORX: T40-T45-T50-T55-T60-T70
 - TORX(W/TAMPER): TH40-TH45-TH50-TH55-TH60-TH70
- 17-1/2"Dr.SPLINE SOCKET:
 - 10-11-12-13-14-15-16-17-18-19-20-21-22-24-27-30-32
- 5-1/2"Dr.DEEP SPLINE SOCKET: 14-15-17-19-22 mm
- 2-1/2"Dr. "E " SOCKET: E20-E24
- 1-1/2"DR. OVAL RATCHET HANDLE (QUICK RELEASE) W/ 72T
- 2-1/2"Dr.EXTENSION BAR: 5" & 10"
- 2-1/2"Dr.SPARK PLUG SOCKET: 16mm & 21mm
- 1-1/2"Dr.UNIVERSAL JOINT
- 1- 1/2"M x 3/8"F TM - HEAD
- 1-1/2"Dr. x 5/16" BIT ADAPTOR
- 7-HEX KEY WRENCH : 1.27-1.5-2-2.5-3-4-5mm



(PAT.NO: M310794)

KA-1194

176pcs 1/4" & 3/8" & 1/2" Socket Set

- 13-1/4"Dr.SOCKET W/SUPER LOCK:
 - 4-4.5-5-5.5-6-7-8-9-10-11-12-13-14
 - 7-1/4"Dr.DEEP SOCKET W/SUPER LOCK: 4-5-6-7-8-9-10 mm
 - 5-1/4"Dr. "E" SOCKET : E4-E5-E6-E7-E8
 - 2-1/4"Dr.EXTENSION BAR: 2" & 4"
 - 1-1/4"DR. OVAL RATCHET HANDLE (QUICK RELEASE) W/72T
 - 1-1/4"Dr.SPINNER HANDLE
 - 1-1/4"Dr.UNIVERSAL JOINT
 - 1-1/4"Dr.SLIDING T-BAR
- 33-1/4"Dr.BIT SOCKET:
 - HEX: 3-4-5-6mm & SLOTTDE: 4-5.5-6.5-7mm
 - SPLINE: M8-M10-M12 & PHILLIPS: #0-#1-#2
 - POZIDRIV: #0-#1-#2 & TORX: T8-T9-T10-T15-T20-T25-T27-T30
 - TORX(W/TAMPER): TH8-TH9-TH10-TH15-TH20-TH25-TH27-TH30
- 9-TORX "L" TYPE KEY W/ PLACTIC HOLDER:
 - TH10-TH15-TH20-TH25-TH27-TH30-TH40-TH45-TH50
- 9-HEX KEY W/ PLACTIC HOLDER: 1.5-2-2.5-3-4-5-6-8-10mm
- 10-3/8"Dr.SOCKET W/SUPER LOCK:
 - 10-11-12-13-14-15-16-17-18-19
 - 6-3/8"Dr.DEEP SOCKET W/SUPER LOCK: 10-11-12-13-14-15 mm
 - 6-3/8"Dr. "E" SOCKET: E10-E11-E12-E14-E16-E18
 - 1-3/8"DR. OVAL RATCHET HANDLE (QUICK RELEASE) W/72T
 - 1-3/8"Dr.EXTENSION BAR: 5"
 - 1-3/8"Dr.UNIVERSAL JOINT
 - 1-3/8"Dr.SPARK PLUG 18mm
 - 1-3/8"Dr.SQ X 5/16" HEX BIT ADAPTOR
- 24-5/16" x 30L BIT:
 - SLOTTED: 8-10-12 mm & PHILLIPS: #3-#4 & POZIDRIV: #3-#4
 - HEX: 7-8-10-12-14 mm & TORX: T40-T45-T50-T55-T60-T70
 - TORX(W/TAMPER) :TH40-TH45-TH50-TH55-TH60-TH70
- 17-1/2"Dr.SOCKET W/SUPER LOCK:
 - 10-11-12-13-14-15-16-17-18-19-20-21-22-24-27-30-32
 - 2-1/2"Dr.DEEP SOCKET W/SUPER LOCK: 16-18 mm
 - 2-1/2"Dr. "E " SOCKET: E20-E24
 - 3-1/2"Dr. AIR IMPACT SOCKET W/PLASTIC HOLDER : 17-19-21mm
 - 1-1/2"DR. OVAL RATCHET HANDLE (QUICK RELEASE) W/ 72T
 - 2-1/2"Dr.EXTENSION BAR: 5" & 10"
 - 1-1/2"(M) x 3/8"Dr.(F) TM HEAD
 - 2-1/2"Dr.SPARK PLUG SOCKET :16mm & 21mm
 - 1-1/2"Dr.UNIVERSAL JOINT
 - 1-1/2"Dr. x 5/16" BIT ADAPTOR
- 12-GEAR WRENCH W/72T : 8-9-10-11-12-13-14-15-16-17-18-19mm

KA-1224

215pc 1/4" & 3/8" & 1/2" Dr. Superlock Socket Wrench Set (CR-V)

Contents:

- 1/4" Dr. 13 x Sockets : 4, 4.5, 5, 5.5, 6, 7, 8, 9, 10, 11, 12, 13, 14mm
 7 x Deep sockets : 4, 5, 6, 7, 8, 9, 10mm
 5 x E-TX sockets: E4, E5, E6, E7, E8
 1 x Ratchet Handle : 72T
 2 x Extension bars: 2" & 4" 1 x Sliding T-bars
 1 x Universal joint 1 x Spinner handle
 30 x Bit socket 1/4" x 37mmL
 Hex : 3, 4, 5, 6mm & Slotted: 4, 5.5, 6.5, 7mm & PH: 0, 1, 2 & PZ: 0, 1, 2
 TX: T8, T9, T10, T15, T20, T25, T27, T30 & TX: T8, T9, T10, T15, T20, T25, T27, T30
- 3/8" Dr. 10 x Sockets: 10, 11, 12, 13, 14, 15, 16, 17, 18, 19mm
 6 x Deep sockets: 10, 11, 12, 13, 14, 15mm
 6 x E-TX sockets: E10, E11, E12, E14, E16, E18
 1 x Ratchet Handle : 72T
 1 x wobble Extension bar 5" 1 x Spark plug socket: 18mm
 1 x Bit adaptor socket: 3/8" x 8mm 1 x Universal joint
- 1/2" Dr. 14 x Sockets: 13, 14, 15, 16, 17, 18, 19, 20, 21, 22, 24, 27, 30, 32mm
 5 x Deep sockets: 16, 17, 18, 19, 22mm
 3 x E-TX sockets: E20, E22, E24
 1 x Ratchet Handle : 72T 1 x TM-HEAD
 1 x Extension barr 10" 1 x Wobble Extension bar : 5"
 1 x Spark plug sockets: 16mm 1 x Spark plug sockets: 21mm
 1 x Bits adaptor socket: 1/2" x 8mm 1 x Universal joint
 1 x Hex bit socket: H14 (BIT: 6150) 1 x Torx bit socket; TX70 (BIT: 6150)
- 30 x Bits 8mm *30mmL
 Hex : 7, 8, 10, 12mm & Slotted: 8, 10, 12mm & PH: 2, 3, 4 & PZ: 2, 3, 4
 TX: T40, T45, T50, T55, T60 (W/O HOLE) & TX: T40, T45, T50, T55, T60 (WITH HOLE)
 RIBE: 10, 11, 12, 13 & SPLINE: M10, M12 & 5 STAR: TX50 (WITH HOLE)
- 7 x Hex wrenches: 1, 1.5, 2, 2.5, 3, 4, 5mm
 1 x Adaptor bit Socket : 1/4" x 1/4" 1 x Bit Adaptor 1/4" x 1/4"
 1 x Screwdriver 100L stainless Bit Holder
 44 x Bits 1/4" 25mmL
 Hex: 2, 2.5, 3, 4, 5, 6mm(WITH HOLE) & TX: T5, T6, T7 (W/O HOLE) &
 TX: T7 (WITH HOLE)
 RIBE: 5, 6, 7, 8, 9 & SPLINE: 5, 6, 8 & SECURITY BITS : SQUARE: #0, #1, #2, #3
 5 STAR: TX10, 15, 20, 25, 27, 30, 40, 45 (WITH HOLE)
 SPANNER: 4, 6, 8, 10 & TORQUES: 6, 8, 10 & TRI WING: #1, #2, #3, #4
 CLUTCH: #1, #2, #3
- 12 x Comb. Wrenches : 8-19mm (European Type 75°)



KA-1225

150pc 1/4" & 3/8" & 1/2" Dr. Superlock Socket Wrench Set (CR-V)

Contents:

- 1/4" Dr. 13 x Sockets : 4, 4.5, 5, 5.5, 6, 7, 8, 9, 10, 11, 12, 13, 14mm
 7 x Deep sockets : 4, 5, 6, 7, 8, 9, 10mm
 5 x E-TX sockets: E4, E5, E6, E7, E8
 1 x Ratchet Handle : 72T
 2 x Extension bars: 2" & 4" 1 x Sliding T-bars
 1 x Universal joint 1 x Spinner handle
 30 x Bit socket 1/4" x 37mmL
 Hex : 3, 4, 5, 6mm & Slotted: 4, 5.5, 6.5, 7mm & PH: 0, 1, 2 & PZ: 0, 1, 2
 TX: T8, T9, T10, T15, T20, T25, T27, T30 & TX: T8, T9, T10, T15, T20, T25, T27, T30
- 3/8" Dr. 10 x Sockets: 10, 11, 12, 13, 14, 15, 16, 17, 18, 19mm
 6 x Deep sockets: 10, 11, 12, 13, 14, 15mm
 6 x E-TX sockets: E10, E11, E12, E14, E16, E18
 1 x Ratchet Handle : 72T
 1 x wobble Extension bar 5" 1 x Spark plug socket: 18mm
 1 x Bit adaptor socket: 3/8" x 8mm 1 x Universal joint
- 1/2" Dr. 17 x Sockets: 10,11,12,13, 14, 15, 16, 17, 18, 19, 20, 21, 22, 24, 27, 30, 32mm
 5 x Deep sockets: 16, 17, 18, 19, 22mm
 2 x E-TX sockets: E20, E24
 1 x Ratchet Handle : 72T 1 x TM-HEAD
 1 x Extension barr 10" 1 x Wobble Extension bar : 5"
 1 x Spark plug sockets: 16mm 1 x Spark plug sockets: 21mm
 1 x Bits adaptor socket: 1/2" x 8mm 1 x Universal joint
- 24 x Bits 8mm *30mmL
 Hex : 7, 8, 10, 12, 14mm & Slotted: 8, 10, 12mm & PH: 3, 4 & PZ: 3, 4
 TX: T40, T45, T50, T55, T60,T70 (W/O HOLE) &
 TX: T40, T45, T50, T55, T60,T70 (WITH HOLE)
- 7 x Hex wrenches: 1.27, 1.5, 2, 2.5, 3, 4, 5mm





KA-8350 30pcs 1/2"Dr. Hexagon Tip Bit Socket Set

- Material: 10mm bit~S2 steel, over 12mm(shank) bit CR-V steel, CR-V tip bit socket set
- 9-55mmL: 5-6-7-8-10-12-14-17-19mm
- 8-100mmL: 5-6-7-8-10-11-12-13mm
- 7-140mmL: 5-6-7-8-10-12-14mm
- 6-200mmL: 5-6-7-8-10-12mm
- All in blow mold case



KA-8351 26pcs 1/2"Dr. Spline Tip Bit Socket Set

- Material: 10mm bit S2 steel, over 12mm(shank) bit CR-V steel, CR-V tip bit socket set
- 8-55mmL: M5-6-8-9-10-12-14-16
- 7-100mmL: M5-6-8-9-10-12-14
- 7-140mmL: M5-6-8-9-10-12-14
- 4-200mmL: M8-10-12-14
- All in blow mold case



KA-8352 32pcs 1/2"Dr. Torx Tip Bit Socket Set

- Material: 10mm bit~S2 steel, over 12mm(shank) bit CR-V steel, CR-V tip bit socket set
- 10-55mmL: T-20, 25, 27, 30, 40, 45, 50, 55, 60, 70
- 10-100mmL: T-20, 25, 27, 30, 40, 45, 50, 55, 60,70
- 6-140mmL: T-40, 45, 50, 55, 60, 70
- 6-200mmL: T-40, 45, 50, 55, 60, 70
- All in blow mold case



KA-8353 32pcs 1/2"Dr. Ribe Tip Bit Socket Set

- Material: 10mm bit~S2 steel, over 12mm(shank) bit CR-V steel, CR-V tip bit socket set
- 9-55mmL: M5-6-7-8-9-10-12-13-14
- 9-100mmL: M5-6-7-8-9-10-12-13-14
- 7-140mmL: M8-9-10-10-12-13-14
- 7-200mmL: M8-9-10-12-13-14
- All in blow mold case



KA-8357 38pcs 1/2" Dr. Socket Bit Set

- 6pcs 140mmL star socket bit: T-40,45,50,55,60,70
- 1pcs star socket bit (tamper proof): T-80 x 100mmL
- 1pcs spline socket bit (tamper proof): M16 x 55mmL
- 5pcs splone socket bit:
M9x100mmL, M10x140mmL, M12x140mmL, M14x140mmL, TM16x10
- 1pcs spline socket bit: M18x78mmL
- 4pcs ribet socket bit:
R7x240mmL, R8x240mmL, R9x100mmL, R10x140mmL
- 1pcs ball point hex socket bit: H5x160mmL
- 4pcs hex socket bit: H10, H11, H13x140mmL, H7x230mmL
- 5pcs 50mmL hex socket bit: H14, H17, H19, H22, H24
- 9pcs 37mmL TS socket bit (tamper proof):
TS-10,15,20,25,27,30,40,45,50,t30x300mmL

KA-1615 13pcs Combined Socket For Alternator

Remove and install press-on type belt drive accessory pulleys.
Use an air impact tool or 1/2" ratchet or breaker bar

- Content: Complete kit for alternator, Pulleys type BOSCH
- Application: VW, Audi, Seat, Mercedes, Renault, BMW, Ford, Fiat, etc...



KA-1615A

KA-1616 18pcs Combined Socket Set For Alternator

3- Combined Socket for Alternator: 1/2"Dr. x 110mm(L): T50 & M10
3/8"Dr. x 82mm(L): M10

- 2- 15mm Hex x 33 teeth, 22mm Hex x 33 teeth
- 1- Special tool for Bosch System Alternator: Ø 34.5 x H17mm x 30L
- 3- Special tool for Renault System Alternators:
 - H22 x H22mm x 30L
 - H28 x H22mm x 30L
 - H28 x H19mm x 30L
- 1- 1/2"Dr. Bit Adaptor
- 6- 10mm x 75L bit: (6150)
 - Torx: T40-T50 & Spline: M8-M10 & Hex: H8-H10
- 1- 12mm x 64L bit (6150) : Spline: M10
- 2- 1/2"Dr. Spline Bit Socket (140mmL): M10



KA-1617

22pcs Complete kit for Bosch and DENSO Type Alternator Pulleys

3- Combined Socket for Alternator: T50 x 113mmL Socket; M10 x 113mmL Socket;
3/8"Dr. x M10 x 80mmL W/ Ø14x33T for Fiat.

- 1- Bit socket M10x140mmL.
- 3- Teeth Socket: 15mm Hex x 19mm x 33 teeth, 22mm Hex x 33 teeth,
15mm Hex x 17.5mm x 33 teeth.
- 2 - 22mm HEX Socket 17mm HEX Socket.
- 3- 22 x 28 mm Hex socket, 19 x 28 mm Hex socket, 21 x 28mm Hex socket.
- 1 - 35mm Round Socket W/4 pins.
- 1 - 38mmHex W/3Pins.
- 1 - 1/2" Dr. SQ.(F) x 10mm Hex.(F) Bits Adaptor.
- 1-M10 x H12 x 64L bit.
- 6 - 10mm(Hex Shank) x 75mmL CR-V bit: T40, T50, M8, M10, H8, H10.



Features :

- Removes and installs press-on-type belt drive accessory pulleys.
- Works with hand tools or an impact gun.
- Interchangeable components to work on VW, Audi, Seat, Mercedes Benz, Renault, BMW, Ford Renault, Fiat, etc....

KA-1323K 6pcs Alternator Freewheel Pulley Removal Set

Easy removal of free wheel pulley from alternator either on or off the vehicle. Allows alternator shaft to be held while the pulley retainer is removed.

- Applications: Audi, BMW, Citroen, Ford, Mercedes, Opel, Peugeot Renault, Vauxhall, Skoda.
- Socket Insert: D: TRX T50 x 64mmL (Driver: 12mm hex)
C: XZN M10 x 64mmL (Driver: 12mm hex)
B: XZN M10 x 110mmL (Driver: 1/2" socket)
A: XZN M10 x 140mmL (Driver: 1/2" socket)
- Locking Insert: F: 33T x Ø 19.5mm (Driver: 21mm hex)
E: 28mm hex (Driver: 21mm hex)



3pcs Alternator Pulley Free Wheel Wrench

KA-3988K content: KA-3988A, KA-3988B, KA-3988C

KA-3988KA content: KA-3988A, KA-3988B, KA-3988C-19





KA-1303 46pcs 1/4" DR. Socket Wrench Set

- 2-1/4"Dr. extension bar 50mm & 100mm
- 1-1/4"Dr. flexible extension bar 150mm
- 1-1/4"Dr. sliding T bar
- 1-1/4"Dr. spinner handle
- 1-1/4"Dr. universal joint
- 1-1/4"Dr. ratchet handle w/quick release(oval)
- 21-1/4"Dr. bit socket:
 - PH: 1-2-3 & PZ:1-2-3 & SL:4-5.5-7 &
 - HEX: 3-4-5-6-7-8 & TORX: T10-T15-T20-T25-T30-T40
- 1-1/4"Dr. socket adaptor
- 4-Hex key wrench: 1.27-1.5-2-2.5mm
- 13-1/4"Dr. socket: 4-4.5-5-5.5-6-7-8-9-10-11-12-13-14mm



KA-7260

1/4" Square Drive With Socket & Bit Drivers Set and auxiliary Shaft

- A new type of screwdriver combines with the auxiliary shaft inside the screwdriver handle.
- The auxiliary shaft let user fasten and release the screw or nut much easier.
- Chrome vanadium steel blade with chrome plated finish.
- The set is supplied with 16 hardened bits (8mm hex) & 2 sockets & 1 adaptor 1/4" sq. drive x 8mm hexagon & 1 adaptor 1/4" sq. drive x 1/4" hexagon.



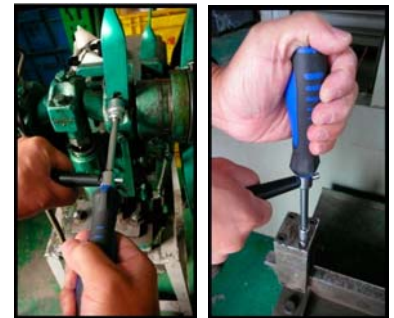

	USA	EUROPE
Hex	6,, 7, 8, 10mm 1/4", 7/32", 5/16", 3/8"	6, 7, 8, 10mm
Torx	T30,T40, T45, T50	T30, T40, T45, T50
Slot	3/8", 9/32"	8mm, 10mm
Spline		8mm, 10mm
PZ		PZ3, PZ4
PH	PH3, PH4	PH3, PH4
Socket	1/2", 9/16"	13, 14mm



KA-1327K 18pcs Shock Absorber Tool Set

For repair work at the spring strut, shock absorbers, removing strut unit. For retaining the piston when installing and removing strut unit.



	Ratchet wheel, pawl, shift lever, 2 screws, ball and compression spring
	6-point: 16, 17, 18, 19, 21, 22, 24mm
	T50: 16, 17, 18, 19, 21, 22, 24mm
	For repair work at the spring strut, especially for retaining the piston road when installing or removing strut units. 7mm for MERCEDES-BENZ Vaneo 8mm for BMW 9mm for OPEL Corsa B, Astra F, G, Vectra B
	<ul style="list-style-type: none"> ⊙ 6, 7, 8mm ⊙ 5 x 8mm ⊙ 6 x 8mm For PORSCHE Cayenne S, VW-Touareg <ul style="list-style-type: none"> ⊙ 7.1 x 9.6mm

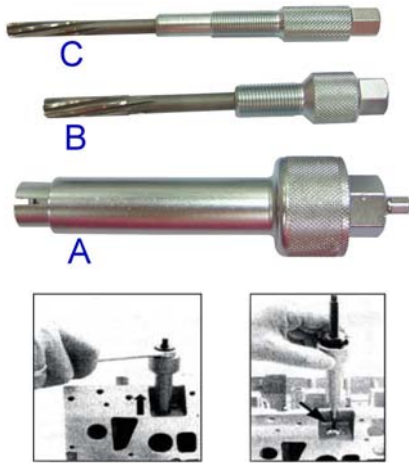

KA-1330 3pcs Pre-Heater Plug Puller Set

To ream out and clean the bore between the glow plug and pre-combustion chamber.

- A:** For pre-heater plugs with 10mm across flats on Mercedes CDI engines (OM611, 612, 613 etc)
 - For pulling out pre-heater plugs after have been unscrewed but are still located firmly in their holes.
 - Length: 135mm
 - Drive: 19mm hex
- B:** For Mercedes 4-Valve-engies OM604, OM605, OM606 with glow plug threads
 - Size: M12 x 1.25
 - Drive: 13mm hex
 - Glow plug: 7mm
- C:** Important if the engine is difficult to start.
For Mercedes CDI engines 4.5 & 6 cylinder OM611, 612, 613 with glow plug threads M10 x 1
 - Drive: 10mm hex
 - Glow plug: 6mm

KA-1331K 6pcs Pre-Heater Plug Puller Set

To ream out and clean the bore between the glow plug and pre-combustion chamber.



- A:** For pre-heater plugs with 10mm across flats on Mercedes CDI engines (OM611, 612, 613 etc)
 - For pulling out pre-heater plugs after have been unscrewed but are still located firmly in their holes.
 - Length: 135mm
 - Drive: 19mm hex
- B:** For Mercedes 4-Valve-engies OM604, OM605, OM606 with glow plug threads
 - Size: M12 x 1.25
 - Drive: 13mm hex
 - Glow plug: 7mm
- C:** Important if the engine is difficult to start.
For Mercedes CDI engines 4.5 & 6 cylinder OM611, 612, 613 with glow plug threads M10 x 1
 - Drive: 10mm hex
 - Glow plug: 6mm

3pcs 3/8" Dr. Glow Plug Socket

Size: 8, 9, 10 length: 83mm

Chrome vanadium steel sockets in carefully selected set of size. Hardened and tempered with chrome finish for corrosion resistance. Handles rounded fixings as well. Set supplied on socket rail and backed by lifetime warranty. These sockets have a universal joint for easy replacement and removal of popular sized glow plugs.

KA-1332K 9pcs Pre-Heater Plug Puller Set

To ream out and clean the bore between the glow plug and pre-combustion chamber.



- A:** For pre-heater plugs with 10mm across flats on Mercedes CDI engines (OM611, 612, 613 etc)
 - For pulling out pre-heater plugs after have been unscrewed but are still located firmly in their holes.
 - Length: 135mm
 - Drive: 19mm hex
- B:** For Mercedes 4-Valve-engies OM604, OM605, OM606 with glow plug threads
 - Size: M12 x 1.25
 - Drive: 13mm hex
 - Glow plug: 7mm
- C:** Important if the engine is difficult to start.
For Mercedes CDI engines 4.5 & 6 cylinder OM611, 612, 613 with glow plug threads M10 x 1
 - Drive: 10mm hex
 - Glow plug: 6mm

6pcs 3/8" Dr. Glow Plug Socket

Size: 8, 9, 10, 12, 14, 16 length: 160mm

Chrome vanadium steel sockets in carefully selected set of size. Hardened and tempered with chrome finish for corrosion resistance. Handles rounded fixings as well. Set supplied on socket rail and backed by lifetime warranty. These sockets have a universal joint for easy replacement and removal of popular sized glow plugs.

3/8" Torque Wrench

- Adapters measure 2" from the center of the adapter opening to the center of the square drive for easy torque calculations
- High strength, thin wall design
- Applies up to 15% more torque to fastener
- Reduces risk of fastener rounding



- KA-1021-08** 3/8" x 8mm
- KA-1021-10** 3/8" x 10mm
- KA-1021-12** 3/8" x 12mm
- KA-1021-14** 3/8" x 14mm
- KA-1021-17** 3/8" x 17mm

3/8"(9.5mm) Tap Holder Socket (タップホルドソケット)

- Attach to any 3/8" Ratchet Wrench or T-bar to use.
ソケット用ハンドルでタップ作業ができます



- KA-2985** Capacity: M4 ~ M8
 - KA-2986** Capacity: M10 ~ M12
 - KA-2987** Capacity: M13 ~ M14
- Min. order: 300 pcs.

Attach to Ratchet Wrench



Attach to T Bar or Ratchet Wrench



**Composite Ratchet Wrench
72 Teeth W/Quick Release**



- KA-2710** 1/4"
- KA-2711** 3/8"
- KA-2712** 1/2"

72 Teeth Ratchet Handle

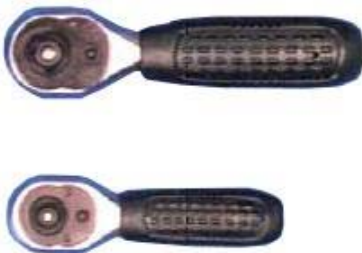

- KA-7360** 3/8"DR (5")
- KA-7361** 1/4"DR (3-3/4")

72 Teeth Flexible Locking Ratchet Handle



- KA-7362** 1/2"dr (11")
- KA-7363** 3/8"dr (8")
- KA-7364** 1/4"dr (5")

One Hand Switch Ratchet Handle

KA-4269A 1/4" x 60T **KA-4269B** 3/8" x 60T **KA-4269C** 1/2" x 60T



Ergonomic Grip

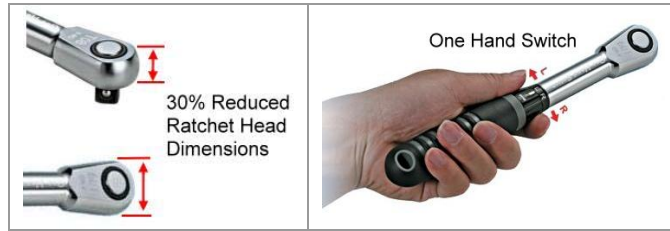

KA-3572 Pocket Tool Set

- Length: 110mm
- Torque: 250 kgf /cm
- Handle: PP + Fiber
- Ratchet Wrench 36-teeth ratchet wrench
- 12pcs bits 25L 8660 sandblast:
PH1, 2, 3, -4, -6
PZ1, 2, S1, S2, HEX3, HEX4, AD



KA-1298 3pcs Palm Ratchet Wrench Socket Adapter Set

Adapter size: 1/4" Sq-Dr. x 13mm
3/8" Sq-Dr. x 19mm
1/2" Sq-Dr. x 24mm

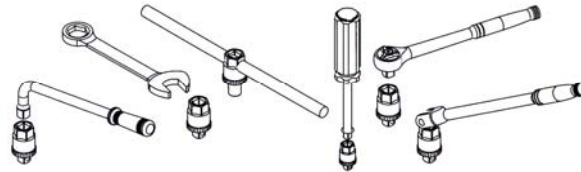

KA-1292 3pcs Spinner Buddies Set

W/O Ratcheting Mechanism

- Use your fingers to take the slack out of a bolt or nut so your ratchet can take over.
- Use as a plan drive for hand installations.
- Consists: 1/4", 3/8", 1/2"



KA-1292A 7-In-1 Ratchet Spinner

- Ideal for getting into tight places.
- Two way usages. One side is for bits, the other is for sockets.
- Built-in magnet can attract bits firmly.
- The opposite side is a 1/4" driver for sockets.
- Patented ratchet design makes the work easier.
- Delicate design-light and easy to carry.
- Bright colorful outlook is attractive to customers.
- Two-way bits increase values and efficiency.



Different sides for bits or sockets



Easy to use in tight areas



KA-1196



KA-1196A

6pcs 3/8"Dr. Jointed Glow Plug Socket Set

- 3/8"Dr.
- Size: 8-9-10-12-14-16mm

KA-1196 Length: 72mm, with clip

KA-1196A Length: 83mm



KA-1197



KA-1197A

6pcs 3/8"Dr. Jointed Glow Plug Socket Set

- 6-3/8"DR. x 158mm
- size: 8-9-10-12-14-16mm

KA-1197 without clip

KA-1197A with clip



KA-1196B 5pcs 1/4" Dr. Glow Plug Socket

- 1/4" Dr.
- Size: 8-9-10-12-14mm
- Length: 70mm



KA-1198

4pcs 3/8" "T" Type Universal Joint Spark Plug Socket Set

- 1-3/8"Dr. x 200mm Sliding T Bar
- 1-3/8"Dr. x 250mm Quick Extension Bar
- 2-3/8"Dr. x universal joint spark plug socket: 5/8" & 13/16"



KA-1199

6pcs 3/8" "T" Type Universal Joint Spark Plug Socket Set

- 1-3/8"Dr. x 200mm Sliding T Bar
- 1-3/8"Dr. x 250mm Quick Extension Bar
- 4-3/8"Dr. x universal joint spark plug socket: 9/16" & 5/8" & 3/4" & 13/16"



KA-7814H Hex Nut Driver Set

Contents:

KA-7814H-2	2mm
KA-7814H-3	3mm
KA-7814H-4	4mm
KA-7814H-5	5mm
KA-7814H-6	6mm
KA-7814H-8	8mm



KA-7814-T T/4 Screwdriver

Contents:

KA-7814-T15	15mm
KA-7814-T20	20mm
KA-7814-T25	25mm
KA-7814-T30	30mm



KA-7814-HD Hex Nut Drivers

Contents:

KA-7814-HD7	7mm
KA-7814-HD8	8mm
KA-7814HD10	10mm
KA-7814HD13	13mm



KA-7814 Special Screwdriver

- 3mm x 300mm Adjust Screwdriver
- 3mm x 6 PT



T-Handle Spark Plug Wrench With Swiveling Socket

KA-6890-16M	16mm (5/8")
KA-6890-21M	21mm (13/16")



KA-5088-38T T-Handle With Foam Handle

- 3/8" 120 x 280mm
- 10MM DIA.



T-Handle Sliding Wobble

- KA-7423** 1/4" 120 x 150mm
- KA-7424** 3/8" 200 x 250mm
- KA-7425A** 1/2" 200 x 250mm



KA-4176K 10pcs T-Handle & Nut Driver Set (Hex)

- 5/16" DR. CR-V
- Content:

KA-4176A size: 8mm	KA-4176F size: 13mm
KA-4176B size: 9mm	KA-4176G size: 14mm
KA-4176C size: 10mm	KA-4176H size: 17mm
KA-4176D size: 11mm	KA-4176I size: 19mm
KA-4176E size: 12mm	



T-Handle Socket (Hex)

- KA-4177A** 8 x 9 x 10mm
- KA-4177B** 8 x 10 x 12mm
- KA-4177C** 10 x 11 x 13mm
- KA-4177D** 10 x 12 x 14mm
- KA-4177E** 12 x 14 x 17mm



3/8" Dr. Adjustable Extension Bar (CRV)

MODEL	ADJUSTABLE LENGTH	WEIGHT
KA-7329	7-10", 178-254MM	300g
KA-7330	9-15", 228-380MM	360g

1/2" DR. Adjustable Extension Bar (CRV)

MODEL	ADJUSTABLE LENGTH	WEIGHT
KA-7336	7-10", 178-254MM	430g
KA-7337	10-16", 254-400MM	600g



KA-7342B Multi Drive Angle Sliding T-Handle

- Can be use for Sliding T-Bar
- Can be Foldable
- Drive angle can be: 75° 90° 105°
- Drive: 1/2" x 3/8" x 1/4"
- Length: 230 x 250mm

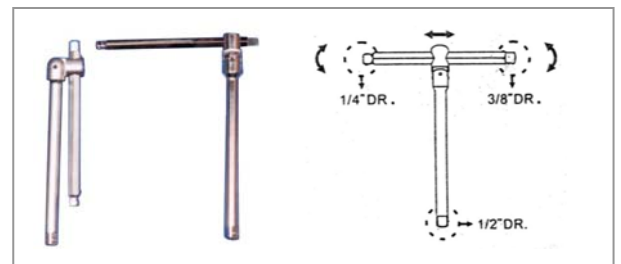



Sliding T-Handle Socket (CRV) (HEX)

■ Length: 200x300mm

MODEL	SIZE: mm
KA-7343B	8
KA-7344B	9
KA-7345B	10
KA-7346B	11
KA-7347B	12

MODEL	SIZE: mm
KA-7348B	13
KA-7349B	14
KA-7349B1	17
KA-7349B2	19



T-Handle Socket (CRV) (HEX)

■ Length: 200x300mm

MODEL	SIZE: mm
KA-7350	8
KA-7351	9
KA-7352	10
KA-7353	11
KA-7354	12

MODEL	SIZE: mm
KA-7355	13
KA-7356	14
KA-7357	17
KA-7358	19



KA-7359 3 Way T-Handle Socket (HEX)

■ Size: 8, 10, 12mm(CRV)

■ Length: 130 x 140mm

■ Content: **KA-7359A** 8 x 10 x 12mm
KA-7359B 10 x 12 x 14mm
KA-7359C 9 x 11 x 13mm



Foldable Cross Ram Wrench (CR.V)

KA-7327C 16", 1/2" DR. & 17, 19, 21mm

KA-7327D 14", 1/2" DR & 17, 19, 21mm



Sliding T-Handle With Swivel Socket

■ Length: 200 x 450mm

KA-5088A	6mm	KA-5088F	12mm
KA-5088B	8mm	KA-5088G	13mm
KA-5088C	9mm	KA-5088H	14mm
KA-5088D	10mm	KA-5088I	17mm
KA-5088E	11mm	KA-5088J	19mm



Adjustable Wobble Extension Sliding T Handle

KA-7387W 3/8"DR 10"~16"(250~400mm)

KA-7388W 1/2"DR 10"~16"(250~400mm)

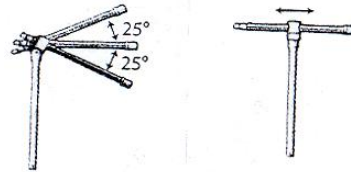

Adjustable Wobble Extension Bar

KA-7326W 1/4"DR 8"~12"(200~300mm)

KA-7330W 3/8"DR 9"~15"(225~375mm)

KA-7337W 1/2"DR 10"~16"(250~400mm)



5pcs Wobble Extension Bar Set

KA-5089A 1/4" DR x 50, 75, 100, 150, 225mm

KA-5089B 3/8" DR x 38, 75, 150, 250, 450mm

KA-5089C 1/2" DR x 50, 125, 250, 375, 500mm



5pcs Extension Bar Set

KA-6384A 1/4" x 50, 75, 100, 150, 225mm

KA-6384B 3/8" x 38, 75, 150, 250, 450mm

KA-6384C 1/2" x 50, 125, 250, 375, 500mm



KA-5087 1/4"DR Adjustable Wobble Extension Set

With: 1pc 1/4"dr 7"~12"(175~300mm)

Adjustable extension bar

1pc 1/4"dr mini ratchet handle 6"(150mm)



KA-5087A
1/4" Adjustable Wobble Extension Bar
■ 7"x12"

KA-5087B
1/4"DR Mini Ratchet Handle 6"

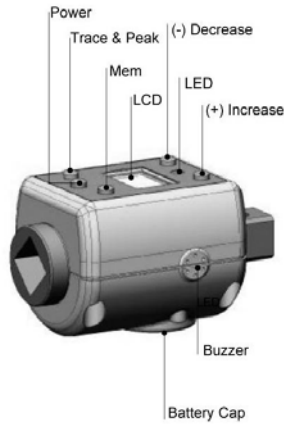

Digital Torque Adapter (5 unit set)

KA-1621, KA-1683, KA-1641, KA-1643

Function:

- 50 memory record
- Track and Peak hold mode
- Auto shut off: 80 seconds (if do not use digital torque adapter)
- **5 unit set (kg-cm, kg-m, lb-in, lb-ft, N-m)**

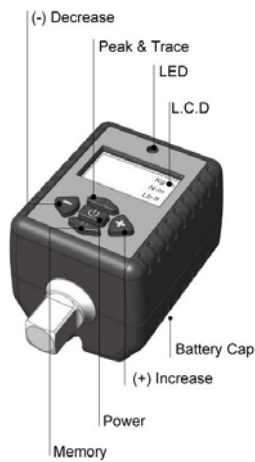

Digital Torque Adapter (3 unit set)

KA-1621A, KA-1683A, KA-1641A

Function:

- 50 memory record
- Track and Peak hold mode
- Auto shut off: 80 seconds (if do not use digital torque adapter)
- **3 unit set (kg-m, lb-ft, N-m)**
- **LED indicator: Green, Yellow, Red**
- **Overload Alarm(125%): 250N-m, 184.4lb-ft**

Features:

Model No.	KA-1621 KA-1621A	KA-1683 KA-1683A	KA-1641 KA-1641A	KA-1643
Drive	1/2"	3/8"	1/4"	3/4"
Accuracy	±2%	±2%	±4%	±2%
Display resolution	0.1	0.1	0.1	0.1
Display Range	40~200 N-m (29.5 ~ 147.5 lb-ft)	27 ~ 135 N-m (19.9 ~ 99.6 lb-ft)	6 ~ 30 N-m (3.3 ~ 16.3 lb-ft)	100 ~ 500 N-m (73.8 ~ 369 lb-ft)
Weight	183g	182g	180g	570g
Size	L75 x W45mm			L110 x W56mm
Battery	CR2032 x 1pc			AA x 2pcs
Battery Life (continuous operation)	55 hrs			110 hrs
Operating Ambient Temperature	-10°C ~ 60°C (13.9°F ~ 139.9°F)			
Storage Temperature	-20°C ~ 70°C (-4°F ~ 157.9°F)			
Operating Relative Humidity	Humidity: 15 to 90% noncondensing			

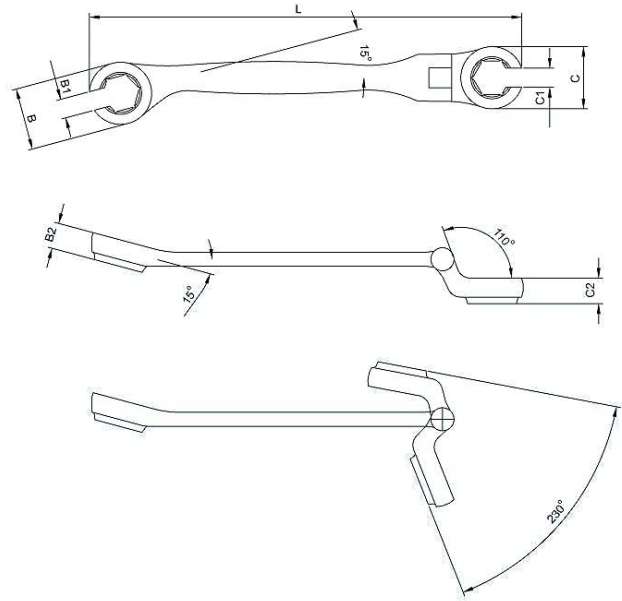

Flexible Nut Wrench

ITEM NO.: KA-2936S / KA-2936M

- MATERIAL: 6140 CRV
- FINISH:KA-2936S (SATIN), KA-2936M (MIRROR)
- HARDNESS: HRC44~48 °C
- PATENTED

All Flexible Combination Wrench are to be used with 3/8" extension bar.



ADVANTAGE * Flexible End * Folds up to 100 degree * Bottom Flare Design
 *Doesn't have Fold up to 100 degree * Doesn't have Bottom Flare Design

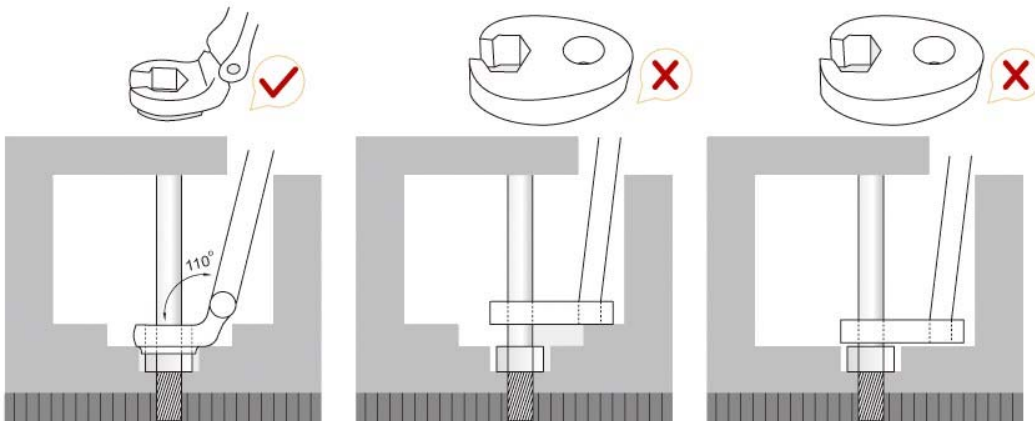

Ergonomic Design

The ergonomically stylish design allows this flare nut wrench to provide equal torque in all directions.

Users are able to continue their work without feeling any discomfort

PATENTED IN U.S.A.,TAIWAN, CHINA, EUROPE.

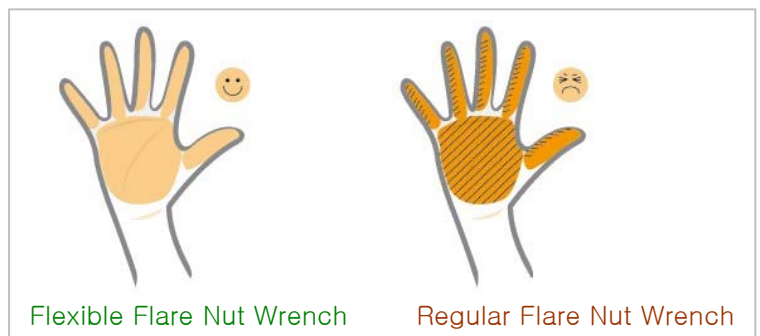

Flexible Flare Nut Wrench

Regular Flare Nut Wrench

DIFFERENCE between Flexible Head and Other Ordinary Flare Nut Wrenches

KA-2936 is design for hard-to-reach areas at up to 45 degrees. This is next to impossible for other ordinary flare nut wrenches. In areas where rotating space is not enough, users need to remove certain obstacles (such as tubing or connectors) before they can loosen or tighten a nut using ordinary flare nut wrenches. This time-consuming and tedious removal can be resolved by using our Flexible Flare Nut Wrench.



Applications for Patented Flexible Flare Nut Wrench



KA-2936S

- SATIN FINISH

KA-2936M

- MIRROR FINISH

KA-2936S/ KA-2936M METRIC SIZE (MM)

ITEM NO. & SIZE (MM)	L (mm)	BXC (mm)	B1XC1 (mm)	B2XC2 (mm)
★08BX08C 8MM	129	18x18	6x6	7x7
08BX09C 8MM	129	18x18	6x6.5	7x7
08BX10C 8MM	129	18x18	6x7	7x7
★09BX09C 9MM	129	18x18	6.5x6.5	7x7
09BX08C 9MM	129	18x18	6.5x6	7x7
09BX10C 9MM	129	18x18	6.5x7	7x7
★10BX10C 10MM	129	18x18	7x7	7x7
10BX08C 10MM	129	18x18	7x6	7x7
10BX09C 10MM	129	18x18	7x6.5	7x7
★11BX11C 11MM	148	22x22	8.5x8.5	9x9
11BX12C 11MM	148	22x22	8.5x9	9x9
★12BX12C 12MM	148	22x22	9x9	9x9
12BX11C 12MM	148	22x22	9x8.5	9x9
★13BX13C 13MM	175	26x26	10x10	11x11
13BX14C 13MM	175	26x26	10x11	11x11
13BX15C 13MM	175	26x26	10x12	11x11
★14BX14C 14MM	175	26x26	11x11	11x11
14BX13C 14MM	175	26x26	11x10	11x11
14BX15C 14MM	175	26x26	11x12	11x11
★15BX15C 15MM	175	26x26	12x12	11x11
15BX13C 15MM	175	26x26	12x10	11x11
15BX14C 15MM	175	26x26	12x11	11x11
★17BX17C 17MM	190	31.6x31.6	14x14	12.8x12.8
17BX19C 17MM	190	31.6x31.6	14x15	12.8x12.8
★19BX19C 19MM	190	31.6x31.6	15x15	12.8x12.8
19BX17C 19MM	190	31.6x31.6	15x14	12.8x12.8
★21BX21C 21MM	235	41x41	16x16	16x16
21BX22C 21MM	235	41x41	16x17	16x16
21BX24C 21MM	235	41x41	16x18	16x16
★22BX22C 22MM	235	41x41	17x17	16x16
22BX21C 22MM	235	41x41	17x16	16x16
22BX24C 22MM	235	41x41	17x18	16x16
★24BX24C 24MM	235	41x41	18x18	16x16
24BX21C 24MM	235	41x41	18x16	16x16
24BX22C 24MM	235	41x41	18x17	16x16

KA-2936S/ KA-2936M IMPERIAL (INCH)

ITEM NO. & SIZE (INCH)	L mm	BXC (mm)	B1XC1 (mm)	B2XC2 (mm)
★5/16BX5/16C 5/16"	129	18x18	6X6	7X7
5/16BX3/8C 5/16"	129	18x18	6X7	7X7
★3/8BX3/8C 3/8"	129	18x18	7X7	7X7
3/8BX5/16C 3/8"	129	18x18	7X6	7X7
★7/16BX7/16C 7/16"	148	22x22	8.5X8.5	9X9
★1/2BX1/2C 1/2"	175	26x26	10X10	11X11
1/2BX9/16C 1/2"	175	26x26	10X11	11X11
★9/16BX9/16C 9/16"	175	26x26	11X11	11X11
9/16BX1/2C 9/16"	175	26x26	11X10	11X11
★5/8BX5/8C 5/8"	190	31.6x31.6	14X14	12.8X12.8
5/8BX11/16C 5/8"	190	31.6x31.6	14X14	12.8X12.8
5/8BX3/4C 5/8"	190	31.6x31.6	14X15	12.8X12.8
★11/16BX11/16C 11/16"	190	31.6x31.6	14X14	12.8X12.8
11/16BX5/8C 11/16"	190	31.6x31.6	14X14	12.8X12.8
11/16BX3/4C 11/16"	190	31.6x31.6	14X15	12.8X12.8
★3/4BX3/4C 3/4"	190	31.6x31.6	15X15	12.8X12.8
3/4BX5/8C 3/4"	190	31.6x31.6	15X14	12.8X12.8
3/4BX11/16C 3/4"	190	31.6x31.6	15X14	12.8X12.8
★7/8BX7/8C 7/8"	235	41x41	17X17	16X16
7/8BX1C 7/8"	235	41x41	17X18	16X16
★1BX1C 1"	235	41x41	18X18	16X16
1BX7/8C 1"	235	41x41	18X17	16X16

When assemble a kit, please choose ★ items.

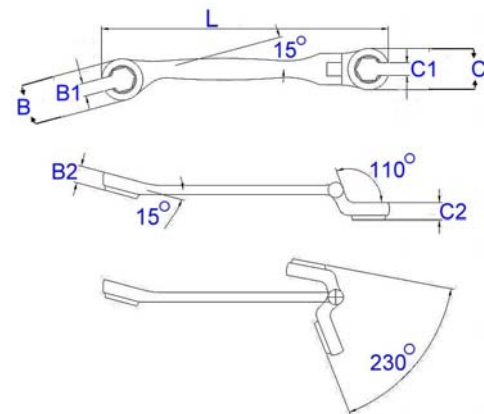



DOUBLE FLEXIBLE FLARE NUT WRENCH

KA-2939S-811 : 8 X 11 MM (SATIN FINISH)
 KA-2939S-1317: 13 X 17 MM (SATIN FINISH)
 KA-2939S-1419: 14 X 19 MM (SATIN FINISH)

KA-2939M-811: 8 X 11MM (MIRROR FINISH)
 KA-2939M-1317: 13 X 17MM (MIRROR FINISH)
 KA-2939M-1419: 14 X 19MM (MIRROR FINISH)

WORLDWIDE PATENT!!

*** More Sizes would be available soon.**

All Flexible Combination Wrench are to be used with 3/8" extension bar.



ADVANTAGE * Flexible End * Folds up to 100 degree * Bottom Flare Design
 *Doesn't have Fold up to 100 degree * Doesn't have Bottom Flare Design

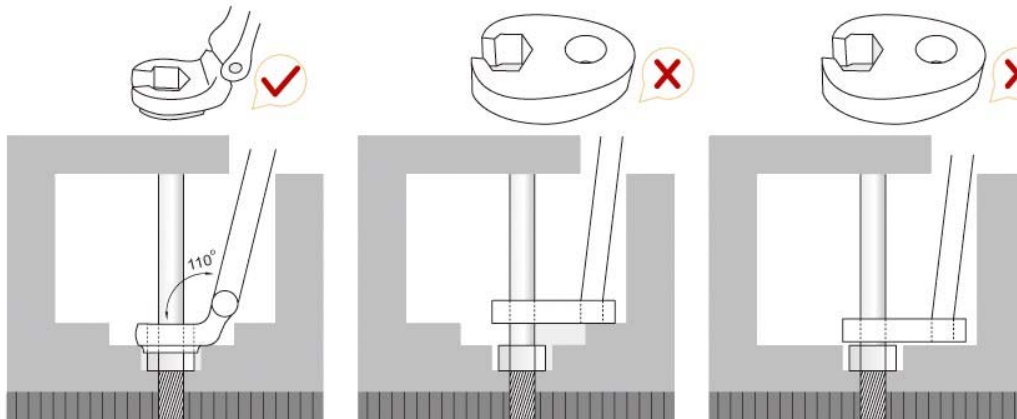

Ergonomic Design

The ergonomically stylish design allows this flare nut wrench to provide equal torque in all directions.

Users are able to continue their work without feeling any discomfort

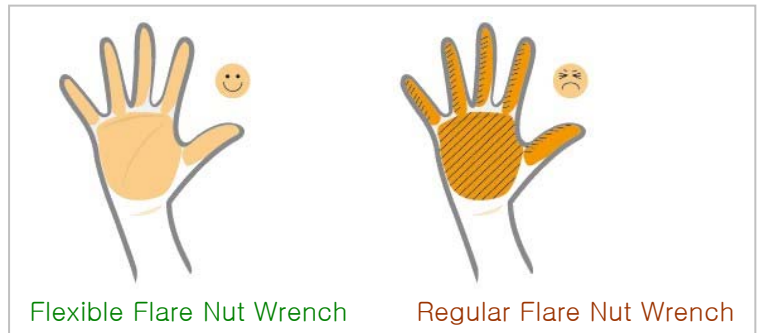

Flexible Flare Nut Wrench

Regular Flare Nut Wrench



4 pcs/set Flexible Flare Nut Wrench Set

- Size: 8,10,11,12mm
- KA-2936KS** SATIN FINISH
- KA-2936KM** MIRROR FINISH



5 pcs/set Flexible Flare Nut Wrench Set

- Size: 8,9,10,11,12mm
- KA-2937KS** SATIN FINISH
- KA-2937KM** MIRROR FINISH



7 pcs/set Flexible Flare Nut Wrench Set

- Size: 8,10,11,12,13,14,17mm
- KA-2938KS** SATIN FINISH
- KA-2938KM** MIRROR FINISH



Flexible Crowfoot Wrench Set

- Package: Hanging Card or Blow Case
- MIN. Order: 500 sets

KA-2940K 10 PCS

- Size:8,9,10,11,12,13,14,15,17,19MM

KA-2941K 8pcs

- Size:5/16", 3/8", 7/16", 1/2", 9/16", 5/8", 11/16", 3/4"



Flexible Combination Wrench Set

- Package: Hanging Card or Blow Case
- MIN. Order: 500 sets

KA-2942K 12pcs

- Size: 8,9,10,11,12,13,14,15,16,17,18,19mm

KA-2943K 8pcs

- Size:5/16", 3/8", 7/16", 1/2", 9/16", 5/8", 11/16", 3/4"



1/4" DR. Torque Wrench

- Length: 275mmL

KA-4386 2~24NM & 0.2~2.4MKG (EUROPEAN TYPE)
KA-4386C 20~240INCH POUNDS & 2~24NM (AMERICAN TYPE)



3/8" DR. Torque Wrench

- Length: 270mmL

KA-4258 120~960 INCH/LBS & 1.4~11.1MKG



3/8" DR. Torque Wrench

- Length: 360mmL

KA-4258BN 19~110NM & 1.9~11MKG (EUROPEAN TYPE)
KA-4258D 5~80FT/LBS & 19~110MKG (AMERICAN TYPE)



1/2" DR. Torque Wrench

- Length: 470mmL

KA-4256 28~210NM & 2.9~21.4MKG (EUROPEAN TYPE)
KA-4256A 10~150FT/LBS & 1.4~20.7MKG (AMERICAN TYPE)



1/2" DR. Torque Wrench

- Length: 470mmL

KA-4257N 28~210NM & 2.9~21.4MKG (EUROPEAN TYPE)
KA-4257AN 10~150FT/LBS & 1.4~20.7MKG (AMERICAN TYPE)



1" DR. Torque Wrench

- Length: 1120mm (44")

KA-4389 140~980NM & 14~99.9MKG (EUROPEAN TYPE)

3/4" DR. Torque Wrench



- Length: 630mmL
- KA-4387A** 50~300FT/LBS & 6.9~41.4MKG (AMERICAN TYPE)
- KA-4387B** 65~415NM & 6.6~42.3MKG (EUROPEAN TYPE)

- Length: 1075mmL
- KA-4388** 140~700NM & 14~71.4MKG (EUROPEAN TYPE)
- KA-4388A** 100~500FT/LBS & 13.8~69.1MKG (AMERICAN TYPE)
- KA-4388B** 100~600FT/LBS & 13.8~83MKG (AMERICAN TYPE)

3/4" Dr. Torque Wrench



- Stain Chrome Plated
- Length: 670mmL
- KA-4393** 60~415NM & 6.6~42.3MKG (EUROPEAN TYPE)
- KA-4393A** 50~300FT/LBS & 6.9~41.4MKG (AMERICAN TYPE)

KA-4253 1/2" DR. Micrometer Adjustable Torque Wrench



- 28~210NM & 2.9~21.4MKG (EUROPEAN TYPE)
- With: 12.7mmx125mm Extension bar
- 9.5mmx12.7mm Adapter
- Length: 500mm (20")

KA-4254 1/2" DR. Micrometer Adjustable Torque Wrench



- 10~150FT/LBS & 1.4~20.7MKG (AMERICAN TYPE)
- With: 1/2"x5" Extension bar
- 3/8"x1/2" Adapter
- Length: 500mm (20")



KA-4394 5pcs Changeable Spanner Torque Wrench

- Torque: 10~18~42-55~65~75NM (EUROPEAN TYPE)
- SPANNER SIZE: 17-22-24-27mm



KA-4395 7pc Changeable Spanner Torque Wrench

- Torque: 10~18~42-55~65~75NM (EUROPEAN TYPE)
- SPANNER SIZE: 17-22-24-26-27-29mm



KA-6637 Motor Angular Torque Gauge

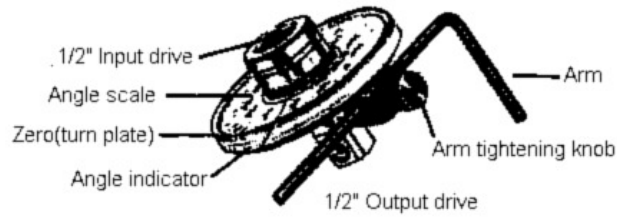

1/2" Dr. Torque Wrench

- Length: 480mm

KA-5113 0~200NM & 0~21MKG (EUROPEAN TYPE)

KA-5112 0~150FT/LBS (AMERICAN TYPE)



3/8" DR. Window Click Type Torque Wrench

- Length: 395mm

KA-4390 14~119NM (EUROPEAN TYPE)

KA-4390A 10~100FT/LBS (AMERICAN TYPE)



1/2" DR. Window Click Type Torque Wrench

- Length: 515mm

KA-4391 42~210NM (EUROPEAN TYPE)

KA-4391A 30~150FT/LBS (AMERICAN TYPE)



3/8" DR. Window Click Type Torque Wrench Kit

KA-4390K 14~119NM (EUROPEAN TYPE)
With: Sockets: 14-17-19-21-23mm
Extension: 12.7x125mm

KA-4390KA 10~100FT/LBS (AMERICAN TYPE)
With: Sockets: 14-17-19-21-23mm
Extension: 1/2"x5"



1/2" DR. Window Click Type Torque Wrench Kit

KA-4392 42~210NM
With: Sockets: 14-17-19-21-23mm
Extension: 12.7x125mm

KA-4392A 30~150FT/LBS
With: Sockets: 14-17-19-21-23mm
Extension: 1/2"x5"



KA-8011 Torque Angle Meter (Clip)

- Use with 1/2" Dr. commonly used for tightening head bolts and other bolts where a torque angle is required.

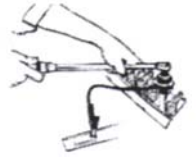

KA-8012 Torque Angle Meter (Magnetic)

- Use with 1/2" Dr. commonly used for tightening head bolts and other bolts where a torque angle is required.



KA-6637A Torque Angular Gauge

- 1/2"



Quick Release Reversible Stubby Ratchet Handle (72 teeth)



Quick Release

Reversible

Part No.	Size	L(mm)			
KA-2310	1/4" Dr.	110	26	22	100
KA-2311	3/8" Dr.	135	32	30	226
KA-2312	1/2" Dr.	170	40	38	442



KA-4236 17pcs Go-Through L-Socket Set

- Extension Bar: 1PC 1/4" x 4", 1PC 3/8" x 6", 1PC 1/2" x 10"
- Socket(10PC): 8-9-10-11-12-13-14-17-19-21
- Adapter(3PC): 1/4" x 1/4", 3/8" x 3/8", 1/2" x 1/2"



KA-4237 8pcs Go-Through L-Socket Set

- Extension Bar: 1PC 1/4" x 4"
1PC 3/8" x 6"
1PC 1/2" x 10"
- Socket: 8-10-13-13-17mm



KA-4238 1/2" DR. 4pcs Go-Through L-Socket Set

- Extension Bar: 1PC 1/2" x 10"
- Socket: 10-19-21mm



KA-4239 3/8" DR. 5pcs Go-Through L-Socket Set

- Extension Bar: 1PC 3/8" x 6"
- Socket: 11-12-13-14mm



KA-4240 1/4" DR. 4pcs Go-Through L-Socket Set

- Extension Bar: 1PC 1/4" x 4"
- Socket: 8-9-10mm



KA-T10020 3/8" Mini T-Bar Ratchet Wrench

- Feature: T-handle allows for free use in confined space.
- Material: CRV
- Finish: Highly Polished Chrome-Plating
- Weight: 274g



KA-T10021 1/4" Mini T-Bar Ratchet Wrench

- Feature: T-handle allows for free use in confined space.
- Material: CRV
- Finish: Highly Polished Chrome-Plating
- Weight: 150g



KA-T10022 3/8" T-Bar Ratchet Wrench w

- Feature: T-handle allows for free use in confined space.
- Material: CRV
- Finish: Highly Polished Chrome-Plating
- Weight: 350g



KA-T10023 1/2" T-Bar Ratchet Wrench w

- Feature: T-handle allows for free use in confined space.
- Material: CRV
- Finish: Highly Polished Chrome-Plating
- Weight: 380g



KA-T10024 3/8" T-Bar Ratchet Wrench w

- Feature: T-handle allows for free use in confined space.
- Material: CRV
- Finish: Highly Polished Chrome-Plating
- Weight: 330g



Extension T-Bar Ratchet Wrench

- KA-T10028 1/2"**
- KA-T10029 3/8"**

- Both ends of the T-handle can be extended.
- Ergonomic, Labor-saving
- Material: CRV
- Finish: Highly Polished Chrome Plating
- KA-T10028 : 700g, KA-T10029: 680g





KA-T10026K 1/2" T-Bar Ratchet Socket Wrench

- Two socket: 17x19mm, 21x23mm
- Great for confined spaces.
- Material: CRV
- Finish: Highly Polished Chrome Plating
- Weight: 1.35g



KA-T10027K 1/2" Four Step Extension Handle

- Great for confined spaces.
- Material: S45C
- Finish: Chrome Plating
- Weight: 880g
- Two socket: 17x19mm, 21x23mm for almost all lug nut.
- Extendable Neck



KA-T10030K 1/2" Separable Cross Wrench

- Unique design, Patent in U.S.A. & Taiwan.
- Two Application:
 - Use alone with the socket
 - Assemble with the 12" long lever to use as a cross wrench. The transverse lever rotate quickly.
- Torque: 60kg
- Dual Head socket: 17 x19mm, 21 x 23mm
- Ergonomic, Labor-saving
- Material: Medium Carbon 45C
- Finish: Matte Golden, Chrome-Plated



Heavy Duty Breaker Bar

- Strong head design for professional use chrome molybdenum steel

KA-4222A 1/2" DR. x 18"

KA-4222B 1/2" DR. x 24"

KA-4222C 1/2" DR. x 30"



Flexible High Torque Ratchet Handle

KA-4221A

- 512Nm (5217 kgf-cm)
- S1/2" x 18"





Opening Singal Ended Ratchet Wrench

Can be used on pneumatic & hydraulic connections such as brake pipes.

hand with coating cove

KA-3480A	10mm	KA-3480G	19mm
KA-3480B	11mm	KA-3480H	22mm
KA-3480C	12mm	KA-3480I	24mm
KA-3480D	13mm	KA-3480J	27mm
KA-3480E	14mm	KA-3480K	32mm
KA-3480F	17mm		
KA-3480K6	6pc/set 10-11-12-13-14-17mm		



Opening Singal Ended Ratchet Wrench

Can be used on pneumatic & hydraulic connections such as brake pipes.

hand satin finish

KA-3481A	10mm	KA-3481G	19mm
KA-3481B	11mm	KA-3481H	22mm
KA-3481C	12mm	KA-3481I	24mm
KA-3481D	13mm	KA-3481J	27mm
KA-3481E	14mm	KA-3481K	32mm
KA-3481F	17mm		
KA-3481K6	6pc/set 10-11-12-13-14-17mm		



Quick Grip Wrench

KA-3482	8", 8~17mm
KA-3483	12", 14~32mm



KA-3484 1/2" Impact-Driver

- 1/2" x 5/16" socket
- 36L BIT PH2, PH3
- 36L BIT SLOTTED -8, -10
- 80L BIT PH2
- 80L BIT SLOTTED -8



KA-3485 3/8" Impact-Driver

- 1-3/8" x 5/16" socket
- 1-3/8" x 1/4" socket
- 2-1/4" x 22L BIT -4, -6
- 3-1/4" x 25L BIT PH1, PH2, PH3
- 3-5/16" x 32L BIT PH1, PH2, PH3
- 2-5/16" x 38L BIT -10-12, -14-16



KA-3486 6pcs Impact-Driver



KA-1200 3pcs 1/2"DR. Shaft Impact Deep Socket Set

- 3-1/2DR. SHAFT IMPACT DEEP SOCKET (12PT): 30-32-36mm
- (CR-Mo steel ,Hardened & Phosphate Finish)



KA-1200A 5pcs 1/2"D R. Shaft Impact Deep Socket Set

- 3-1/2DR. SHAFT IMPACT DEEP SOCKET (12PT): 30-32-34-35-36mm
- (CR-Mo steel ,Hardened & Phosphate Finish)



KA-4262K 3pcs 1/2"D R. Shaft Impact Deep Socket Set

- 3-1/2DR. WHEEL NUT IMPACT DEEP SOCKET: 17-19-21mm
- CR-Mo steel ,Hardened & Color Finish , (Bule, Yellow, Red)
- White Plastic Holder



KA-4263A 5pcs 1/2"Dr. Wheel Nut Impact Deep Socket Set

- 5-1/2DR. WHEEL NUT IMPACT DEEP SOCKET: 15-17-19-21-22mm
- CR-Mo steel ,Hardened & Color Finish , (Green, Bule, Yellow, Red, Purple)
- White Plastic Holder



KA-4263B 5pcs 1/2"D r. Wheel Nut Impact Deep Socket Set

- 5-1/2DR. WHEEL NUT IMPACT DEEP SOCKET: 17-19-21-22-24mm
- CR-Mo steel ,Hardened & Color Finish , (Bule, Yellow, Red, Purple, Jasper)
- White Plastic Holder

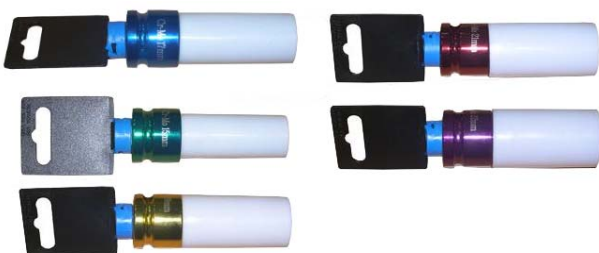

1/2"D r. Wheel Nut Impact Deep Socket Set

- CR-Mo steel ,Hardened
- White Plastic Holder
- w / Plastic Hanger

- KA-4263-1** 1/2"DR. x 15mm
- KA-4263-2** 1/2"DR. x 17mm
- KA-4263-3** 1/2"DR. x 19mm
- KA-4263-4** 1/2"DR. x 21mm
- KA-4263-5** 1/2"DR. x 22mm



KA-1215 8pcs 1/2"Dr. Impact Torx Bit Socket Set

8-IMPACT TORX BIT SOCKET: T30-T40-T45-T50-T55-T60-T70-T80
(CR-Mo steel ,Hardened & Blak Phosphate Finish)



KA-1216 8pcs 1/2"Dr. Impact Hex Bit Socket Set

8-IMPACT HEX BIT SOCKET: 5-6-8-10-12-14-17-19mm
(CR-Mo steel ,Hardened & Blak Phosphate Finish)



KA-1217 8pcs 1/2"Dr. Impact Spline Bit Socket Set

8-IMPACT SPLINE BIT SOCKET: 5-M6-M8-M10-M12-M14-M16-M18
(CR-Mo steel ,Hardened & Blak Phosphate Finish)



KA-1218 8pcs 1/2"Dr. Impact Ribe Bit Socket Set

8-IMPACT RIBE BIT SOCKET: RM5-RM6-RM7-RM8-RM10-RM11-RM12-RM13
(CR-Mo steel ,Hardened & Blak Phosphate Finish)



KA-1219 19pcs 1/2"Dr. Spline Socket Set

19-SPLINE SOCKET: 8-9-10-11-12-13-14-15-16-17-18-19-20-21-22-24-27-30-32
(CR-V steel ,Hardened & Sandblasted Mat plated)



KA-1220 12pcs 1/4"Dr. Spline Socket Set

19-SPLINE SOCKET: 4-5-5.5-6-7-8-9-10-11-12-13-14
(CR-V steel ,Hardened & Sandblasted Mat plated)



KA-1221 6pcs 1/4"Dr. Deep "E" Type Socket Set

6-DEEP "E" TYPE SOCKET: E4-E5-E6-E7-E8-E10
 CR-V steel ,Hardened & Sandblasted Mat plated
 Steel Rack 115mm(L)
 Slide card



KA-1222 6pcs 3/8"Dr. Deep "E" Type Socket Set

11-DEEP "E" TYPE SOCKET: E4-E5-E6-E7-E8-E10-E11-E12-E14-E16-E18
 (CR-V steel ,Hardened & Sandblasted Mat plated)



KA-1223 10pcs 1/2"Dr. Deep "E" Type Socket Set

10-DEEP "E" TYPE SOCKET: E8-E10-E11-E12-E14-E16-E18-E20-E22-E24
 (CR-V steel ,Hardened & Sandblasted Mat plated)



KA-8354 Interchangeable Wrench Socket Set

11pcs- 1/4" Dr. Socket: 4-4.5-5-5.5-6-7-8-9-10-11-12mm
 7pcs- 3/8" Dr. Socket: 13-14-15-16-17-18-19mm
 2pc- 1/2" Dr. Interchangeable Deep Socket: 14mm, 19mm
 1pc- 1/4" Dr. Interchangeable Quick-Release Adapter
 1pc- 3/8" Dr. Interchangeable Quick-Release Adapter
 20pcs- 1/4" Dr. Bit:
 H3, H4, H5, H6, PH1, PH2, PH3, PZ1, PZ2, PZ3., FD4, FD5.5, FD7, T8, T10, T15,
 T20, T25, T27, T30
 1pc- 1/4" Dr. Interchangeable Bit Holder
 9pcs- Interchangeable Socket: 15-16-17
 1pc- Interchangeable Wrench



For Bit



For Deep Bit Socket



For Socket



For Deep Socket

KA-3358K Torque Screw Driver with 28 Bits/Adapters

PATENT: TAIWAN, GERMANY, CHINA, U.S.A

Screwdriver with 28 bits contents:

- 5PCS - Hex bits L25mm: 3, 4, 5, 6, 8mm
 - 5PCS - Slotted bits L25mm: 3, 4, 5.5, 6.5, 7mm
 - 4PCS - Phillips bits L25mm: NO. 0, 1, 2, 3
 - 4PCS - Tri Wing bits L25mm: NO.1, 2, 3, 4
 - 2PCS - Posidrive bits L25mm: No. 1, 2
 - 6PCS - Torx bits L25mm: T10, T15, T20, T25, T30, T40
 - 1PCS - Bit holder L60mm
 - 1PCS - 1/4" Dr. Socket adapter L25mm
- Material : bits steel # S2

Screwdriver:

1PCS - Torque Screw Drivers 1 to 4 NM > ±6% <
 # Torque Screw Driver Body material is compiled with PAHs and pass SGS test.





KA-7311K-10MH
10pcs 3/8"Dr. Metric Flare Nut Crowfoot Wrench Set
 ■ 10PC-MM Size: 10, 11, 12, 13, 14, 15, 16, 17, 18, 19mm



KA-7311K-11SH
11pcs S.A.E Flare Nut Crowfoot Wrench Set
 S.A.E Size: 3/8" DR. 3/8", 7/16", 1/2", 9/16", 5/8", 11/16", 3/4", 1/2" DR. 13/16", 7/8", 15/16", 1"



KA-7311K-11M
11pcs Professional Metric Crowfoot Wrench Set
 Metric Size: 1/2" DR. 20, 21, 22, 23, 24, 25, 26, 27, 28, 30, 32mm



KA-7311K-13M
13pcs Professional Metric Crowfoot Wrench Set
 Metric Size: 1/2" DR. 20, 21, 22, 23, 24, 25, 26, 27, 28, 30, 32mm



KA-7311K-12S
12pcs Professional S.A.E. Crowfoot Wrench Set
 S.A.E. Size :
 3/8" DR. 5/16", 3/8", 7/16", 1/2", 9/16", 5/8", 11/16", 3/4"
 1/2" DR. 13/16", 7/8", 15/16", 1"



KA-7311K-15M
15pcs Professional Metric Crowfoot Wrench Set
 Metric Size:
 3/8" DR. 8, 9, 10, 11, 12, 13, 14, 15, 16, 17, 18, 19mm
 1/2" DR. 21, 22, 24mm



KA-7311K-16S
16pcs Professional S.A.E. Crowfoot Wrench Set
 S.A.E. Size:
 3/8" DR. 5/16", 3/8", 7/16", 1/2", 9/16", 5/8", 11/16", 3/4"
 1/2" DR. 13/16", 7/8", 15/16", 1", 1-1/16", 1-1/8", 1-3/16", 1-1/4"



19pcs Professional Metric Crowfoot Wrench Set
KA-7311K-19M (Silver Finish)
KA-7311K-19MB (Black Finish)
 Metric Size:
 3/8" DR. 8, 9, 10, 11, 12, 13, 14, 15, 16, 17, 18, 19mm
 1/2" DR. 21, 22, 24, 27, 28, 30, 32mm



KA-3987 98pcs Bit Set

- 21-PHILLIPS: #1X7, #2X7, #3X7
- 21-POZI: #1X7, #2X7, #3X7
- 14-SLOTTED: 4X7, 6X7
- 21-HEX: 4X7, 5X7, 6X7
- 14-TX: T10X2, T15X2, T20X2, T25X2, T27X2, T30X2, T40X2
- 7-TAMPER TX: T10, 15, 20, 25, 27, 30, 40
- 1- 60mm stainless magnetic bit holder
- 1- 60mm quick magnetic bit holder



16pcs Pin Punch Set

KA-2304K MM size

- 1-Chisel Gauge
- 3-Flat Chisel: 9.5 x 140mm, 12.7 x 150mm, 16 x 165mm
- 2-Center Punch: 3 x 130mm, 5 x 150mm
- 5-Pin Punch: 2 x 110mm, 3 x 120mm, 4 x 130mm, 5 x 135mm, 6 x 145mm
- 5-Starter Punch: 2.5 x 130mm, 3 x 145mm, 4 x 150mm, 5 x 160mm, 6 x 170mm

KA-2305K Inch Size

- 1-Chisel Gauge
- 3-Flat Chisel: 3/8" x 140mm, 1/2" x 150mm, 5/8" x 165mm
- 2-Center Punch: 1/8" x 130mm, 13/64" x 150mm
- 5-Pin Punch: 3/32" x 110mm, 1/8" x 120mm, 5/32" x 130mm, 3/16" x 135mm, 1/4" x 145mm
- 5-Starter Punch: 3/32" x 130mm, 1/8" x 145mm, 5/32" x 150mm, 3/16" x 160mm, 1/4" x 170mm



8pcs Pin Punch Set

KA-2306K MM size

- 8-Pin Punch:
 - 1.5 x 130mm, 2 x 130mm, 3 x 135mm, 4 x 140mm
 - 5 x 145mm, 5.5 x 150mm, 6 x 155mm, 8 x 160mm

KA-2307K Inch Size

- 8-Pin Punch
 - 1/16" x 130mm, 3/32" x 130mm, 1/8" x 135mm, 5/32" x 140mm
 - 3/16" x 145mm, 7/32" x 150mm, 15/64" x 155mm, 5/16" x 160mm



8pcs Pin Punch Set

KA-2308K MM size

- 8-Pin Punch
 - 1.5 x 130mm, 2 x 130mm, 3 x 135mm, 4 x 140mm
 - 5 x 145mm, 5.5 x 150mm, 6 x 155mm, 8 x 160mm

KA-2309K Inch Size

- 8-Pin Punch
 - 1/16" x 130mm, 3/32" x 130mm, 1/8" x 135mm, 5/32" x 140mm
 - 3/16" x 145mm, 7/32" x 150mm, 15/64" x 155mm, 5/16" x 160mm



Adjustable Torque Screwdriver with Twin Display

- Two windows display for in-lb and N.m.
- Accuracy: ± 6%
- Soft grip handle manufactured from TPR for comfortable use
- Quick change design w/mini effort
- Application: air bag, crash sensor, inertia reel fixtures
- PAT. & SGS

Item No.	In-lb range	N.m. range
KA-1241	5in-lb to 35 in-lb	0.5 N.m. to 4 N.m.
KA-1242	20 in-lb to 90 in-lb	2 N.m. to 10 N.m.

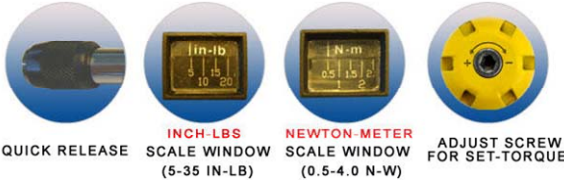

QUICK RELEASE INCH-LBS SCALE WINDOW (5-35 IN-LB) NEWTON-METER SCALE WINDOW (0.5-4.0 N-W) ADJUST SCREW FOR SET-TORQUE

KA-1243 6 N-m Limited Torque Screwdriver

- Removable T-handle for 3/8" tetragonal wrenches
- Torque value: 6 N.m.
- 1/4" hex joint for bits
- Application: Carbon bike screw. CNC cutting tool replacement, Air bag, Crash sensor, Aerospace industry...
- Not suitable for use with impact type wrenches
- Can't be calibrated



KA-3633 Special Wrench for Turbo

The Special Wrench For Turbo

Special wrench for screwing on the turbo-charger in diesel engines of VW / AUDI; new model, short type, from now on very convenient assembling and disassembling for screw underneath the turbo-charger.

- For:VW / AUDI
- Drive: 3/8" □
- Size : 12 mm x 12PT



Open Ended Ring Wrench Socket Set

Specially designed to loosen and tighten nuts and bolts in confined spaces – e.g. Fuel Injector Connections.



Item No.	Content / Size	Description
KA-3634K	KA-3634-12 12	Drive: 1/2" □ Length: 80 mm HEX (6PT)
	KA-3634-14 14	
	KA-3634-16 16	
	KA-3634-17 17	
	KA-3634-18 18	
KA-3635K	KA-3634-19 19	Drive: 1/2" □ Length: 100 mm HEX (12PT)
	KA-3635-12 12	
	KA-3635-14 14	
	KA-3635-16 16	
	KA-3635-17 17	
	KA-3635-18 18	
	KA-3635-19 19	



Offset SAE Grip Wrench

- Those great tools to turn the “hard-to-get” nuts and bolts.
- 25-degree angle enables the user to reach tight situations without scraping their knuckle.
- Reverse by simply flipping the reversing lever with your finger.

Item	content
KA-3958	size: 9/16", point: 6 (KA-3958-6) size: 9/16", point: 12 (KA-3958-12)
KA-3959	size: 5/8", point: 6 (KA-3959-6) size: 5/8", point: 12 (KA-3959-12)



KA-2998 7pcs Screwdriver Set

- Chrome vanadium steel blades
- Thermoplastic soft grip handles
- Precision Ground magnetic tips
- Satin chrome plated
- Contents:

- 4 Slotted
3 x 75mm
5 x 100mm
6 x 100mm
8 x 150mm

- ⊕ 3 PHIP
PH NO.0 x 75mm
PH NO.1 x 75mm
PH NO.2 x 100mm



KA-2999 8pcs Screwdriver Set

- Chrome vanadium steel blades
- Thermoplastic soft grip handles
- Precision Ground magnetic tips
- Satin chrome plated
- Contents:

- 4 Slotted
8 x 150mm
7 x 75mm (6 x 100mm)
3 x 75mm
6 x 38mm

- ⊕ 4 PHIP
PH NO.0 x 75mm
PH NO.1 x 75mm
PH NO.2 x 100mm
PH NO.2 x 38mm



KA-3000 9pcs Gear Type Socket Driver Set

- Chrome vanadium steel blades
- Thermoplastic soft grip handles
- Precision Ground magnetic tips
- Satin chrome plated
- Size: 5-5.5-6-7-8-9-10-11-12mm
- L: 180mm

Preset Type Torque Screwdriver

- Two-value display for in-lb and N.m.
- Soft grip handle manufactured from TPR for comfortable use.
- Persistent fastening for quality control.
- Accuracy: ±6%
- Audible click at achieved torque w/automatic rest.



Application: air valve of wheel



An assembly 1/4" tetragonal adapter for 1/4" standard Hex. bits

Item no.	Torque preset	Torque N.m.	Item no.	Torque preset	Torque N.m.
KA-1244	5 in-lbs	0.56 N.m.	KA-1251	30 in-lbs	3.4 N.m.
KA-1245	7.5 in-lbs	0.85 N.m.	KA-1252	35 in-lbs	3.9 N.m.
KA-1246	10 in-lbs	1.1 N.m.	KA-1253	40 in-lbs	4.5 N.m.
KA-1247	12.5 in-lbs	1.4 N.m.	KA-1254	50 in-lbs	5.6 N.m.
KA-1248	15 in-lbs	1.7 N.m.	KA-1255	60 in-lbs	6.8 N.m.
KA-1249	20 in-lbs	2.2 N.m.	KA-1256	70 in-lbs	7.9 N.m.
KA-1250	25 in-lbs	2.8 N.m.			

Double Open End Wrench –Platinum Wrench



- DROP FORGED
- CHROME VANADIUM SEEL
- A. MIRROR POLISHED
- B. SATIN PLATED

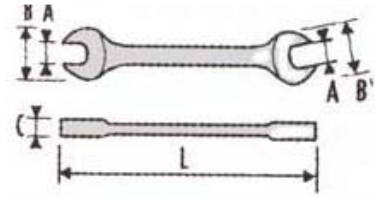

METRIC SIZE

ART NO.	SIZE(mm)	B x B1 (mm)	C x C1 (mm)	L (mm)	ART NO.	SIZE(mm)	B x B1 (mm)	C x C1 (mm)	L (mm)
KT-05-203	6x7	15.5x18.0	3.7	123	KT-05-227	6x8	15.5x18.0	3.7	123
KT-05-204	6x8	15.5x18.0	3.7	123	KT-05-228	8x9	20.4x22.7	4	140
KT-05-206	8x9	20.4x22.7	4	140	KT-05-231	8x10	20.4x22.7	4	140
KT-05-207	8x10	20.4x22.7	4	140	KT-05-234	10x11	24.9x27.1	5	156
KT-05-208	10x11	24.9x27.1	5	156	KT-05-235	10x12	24.9x27.1	5	156
KT-05-209	10x12	24.9x27.1	5	156	KT-05-238	11x13	29.2x31.2	5.5	172
KT-05-211	11x13	29.2x31.2	5.5	172	KT-05-241	12x13	29.2x31.2	5.5	172
KT-05-212	12x13	29.2x31.2	5.5	172	KT-05-245	12x14	31.3x33.3	5.5	180
KT-05-213	12x14	31.3x33.3	5.5	180	KT-05-246	14x15	33.3x35.3	5.9	190
KT-05-218	14x15	33.3x35.3	5.9	190	KT-05-248	14x17	33.3x38.9	6.1	195
KT-05-219	14x17	33.3x38.9	6.1	195	KT-05-252	16x17	37.1x38.9	6.3	204
KT-05-221	16x17	37.1x38.9	6.3	204	KT-05-255	17x19	40.9x42.8	6.7	221
KT-05-223	17x19	40.9x42.8	6.7	221	KT-05-260	46x50	94.5x103.0	16.8	460
KT-05-224	6x7	15.5x18.0	3.7	123					

POUCH BAG SET

ART NO.	SET	SIZE (mm)
KT-0506K	6PCS	8x9, 10x11, 12x13, 14x15, 16x17, 18x19
KT-0508K	8PCS	6x7, 8x9, 10x11, 12x13, 14x15, 16x17, 18x19, 20x22
KT-0511K	11PCS	6x7, 8x9, 10x11, 12x13, 14x15, 16x17, 18x19, 20x22, 21x23, 22x24, 24x27
KT-0512K	12PCS	6x7, 8x9, 10x11, 12x13, 14x15, 16x17, 18x19, 20x22, 21x23, 24x27, 25x28, 30x32mm

Stubby Type Combination Wrench



ITME NO.	SIZE (mm)	A (mm)	B (mm)	C (mm)	D (mm)	L (mm)
KT-02-206	6	13.1	10.0	4.6	5.8	77
KT-02-207	7	15.8	13.3	5.0	5.8	80
KT-02-208	8	17.8	13.5	5.2	5.9	85
KT-02-209	9	18.9	14.2	5.2	6.0	90
KT-02-210	10	22.2	13.1	5.8	7.5	95
KT-02-211	11	23.9	17.9	6.1	7.8	100
KT-02-212	12	25.5	19.1	6.6	7.8	104
KT-02-213	13	27.1	19.9	7.0	9.1	109
KT-02-214	14	29.2	21.8	7.6	9.4	114
KT-02-215	15	30.1	22.5	7.8	9.6	120
KT-02-216	16	32.8	24.1	7.9	9.8	124
KT-02-217	17	35.8	26.1	8.7	10.8	130
KT-02-218	18	36.7	27.0	9.1	11.0	134
KT-02-219	19	38.1	28.6	9.9	11.9	140
KT-02-222	22	39.7	29.8	10.3	12.5	165

Combination Wrench



- DROP FORGED
- CHROME VANADIUM SEEL
- A. MIRROR POLISHED
- B. SATIN PLATED

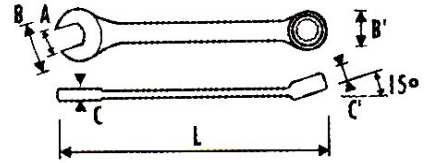

POUCH BAG SET

ART NO.	SET	SIZE (mm)
KT-0106K	6PCS/PH	10, 12, 13, 14, 15, 17mm
KT-0116K	6PCS/PH	8, 9, 10, 14, 17, 19mm
KT-0111K	11PCS/PH	7, 8, 9, 10, 11, 12, 13, 14, 15, 17, 19mm
KT-0121K	11PCS/PH	8, 9, 10, 11, 12, 13, 14, 17, 19, 21, 24mm
KT-0112K	12PCS/PH	8, 9, 10, 11, 12, 13, 14, 15, 16, 17, 19, 22mm
KT-0114K	14PCS/PH	10, 11, 12, 13, 14, 17, 19, 21, 22, 23, 24, 26, 30, 32mm
KT-0124K	14PCS/PH	8, 9, 10, 11, 12, 13, 14, 15, 16, 17, 19, 21, 22, 24mm
KT-0117K	17PCS/PH	8, 9, 10, 11, 12, 13, 14, 15, 16, 17, 18, 19, 20, 21, 22, 23, 24mm
KT-0125K	17PCS/PH	6, 7, 8, 9, 10, 11, 12, 13, 14, 15, 16, 17, 18, 19, 20, 21, 22mm
KT-0126K	26PCS/PH	6, 7, 8, 9, 10, 11, 12, 13, 14, 15, 16, 17, 18, 19, 20, 21, 22, 23, 24, 25, 26, 27, 28, 29, 30, 32mm

METRIC SIZE

ART NO.	SIZE(mm)	B x B1 (mm)	C x C1 (mm)	L (mm)	ART NO.	SIZE(mm)	B x B1 (mm)	C x C1 (mm)	L (mm)
KT-01-206	6	15.5x10.1	4.0x4.7	105	KT-01-225	25	52.0x36.9	8.9x12.5	295
KT-01-207	7	17.0x11.5	4.0x5.0	115	KT-01-226	26	53.6x38.2	9.2x12.8	305
KT-01-208	8	19.2x12.8	4.5x5.5	125	KT-01-227	27	55.7x39.6	9.4x13.1	315
KT-01-209	9	21.2x14.2	4.5x5.9	135	KT-01-228	28	57.6x40.9	9.7x13.3	325
KT-01-210	10	23.2x15.6	5.0x6.5	145	KT-01-229	29	59.7x42.3	9.9x13.5	335
KT-01-211	11	25.3x16.9	5.4x6.9	155	KT-01-230	30	61.8x43.7	10.1x13.7	345
KT-01-212	12	27.2x18.3	5.5x7.3	165	KT-01-232	32	65.8x46.4	10.4x14.3	365
KT-01-213	13	29.4x19.7	5.9x7.8	175	KT-01-233	33	69.5x48.8	10.7x15	392
KT-01-214	14	31.5x21.2	6.2x8.3	185	KT-01-234	34	69.5x48.8	10.7x15	392
KT-01-215	15	33.2x22.5	6.4x8.6	195	KT-01-235	35	74.0x53.0	13.5x19.4	422
KT-01-216	16	34.7x24.0	6.7x8.9	205	KT-01-236	36	74.0x53.0	13.5x19.4	422
KT-01-217	17	36.5x25.3	6.9x9.3	215	KT-01-238	38	77.0x56.0	15.0x20.4	442
KT-01-218	18	38.7x26.8	7.2x9.9	225	KT-01-241	41	84.0x61.0	16.0x21.6	472
KT-01-219	19	40.7x28.1	7.4x10.5	234	KT-01-243	43	84.0x61.0	16.0x21.6	472
KT-01-220	20	43.1x29.7	7.7x10.9	245	KT-01-244	44	92.0x66.0	17.0x23.0	512
KT-01-221	21	44.8x31.3	8.0x11.3	255	KT-01-246	46	92.0x66.0	17.0x23.0	512
KT-01-222	22	46.9x32.6	8.2x11.5	265	KT-01-248	48	102.0x73.0	18.0x24.6	552
KT-01-223	23	48.3x34.2	8.4x11.8	275	KT-01-250	50	102.0x73.0	18.0x24.6	552
KT-01-224	24	50.4x35.5	8.7x12.1	285					

Extra Long Combination Wrench

- DROP FORGED
- CHROME VANADIUM SEEL
- A. MIRROR POLISHED
- B. SATIN PLATED

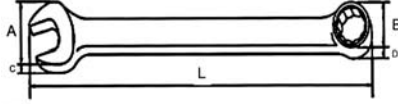

ART NO.	SIZE (mm)	L (mm)	A (mm)	B (mm)	C (mm)	D (mm)	Weight (g)
KT-2610L	10	189	22.8	15.8	5.1	6.9	53
KT-2611L	11	207	24.6	17.3	5.3	7.0	62
KT-2612L	12	225	27.2	18.8	5.6	7.8	77
KT-2613L	13	243	28.6	20.4	5.7	8.5	113
KT-2614L	14	261	31.4	21.8	6.9	9.1	128
KT-2615L	15	279	33.5	23.4	7.0	9.3	144
KT-2616L	16	297	35.3	24.8	7.3	10.0	182
KT-2617L	17	314	37.6	26.2	7.4	1.01	197
KT-2618L	18	333	39.4	27.5	7.8	11.3	223
KT-2619L	19	349	41.5	28.7	8.7	12.7	271

ART NO.	mm	Length (mm)
KT-02-607	7	138
KT-02-608	8	148
KT-02-609	9	160
KT-02-610	10	167
KT-02-611	11	186
KT-02-612	12	196
KT-02-613	13	205
KT-02-614	14	223
KT-02-615	15	233
KT-02-616	16	243
KT-02-617	17	262
KT-02-618	18	272
KT-02-619	19	281
KT-02-620	20	281
KT-02-621	21	301
KT-02-622	22	319
KT-02-623	23	339
KT-02-624	24	339
KT-02-625	25	373
KT-02-626	26	373
KT-02-627	27	388
KT-02-628	28	404
KT-02-629	29	404
KT-02-630	30	404
KT-02-632	32	431

POUCH BAG SET

ART NO.	SET	SIZE (mm)
KT-0110K	10PCS/PH	10, 11, 12, 13, 14, 15, 16, 17, 18, 19mm

Extra Long Double Ring Offset Wrench (0°)



MERTIC SIZE

ITME NO.	SIZE (mm)	C (mm)	B (mm)	C1 (mm)	B1 (mm)	T (mm)	L (mm)
KT-0810L	8x10	15.1	12.6	8.5	7.5	4.4	235
KT-1012L	10x12	19.1	16.2	9.1	8.4	4.6	295
KT-1214L	12x14	26.5	22.2	14.5	12.8	5.8	330
KT-1315L	13x15	26.5	22.2	14.5	12.8	5.8	330
KT-1417L	14x17	26.6	22.2	14.5	12.9	5.8	370
KT-1618L	16x18	29.3	26.6	16.0	15.0	7.0	405
KT-1719L	17x19	29.3	26.6	16.0	15.0	7.0	405
KT-1921L	19x21	29.3	31.0	17.0	16.0	7.0	405
KT-2224L	22x24	35.0	33.0	18.6	17.3	9.2	435

POUCH BAG SET

ART NO.	SET	SIZE (mm)
KT-0804K	4PCS/PH	10x12, 14x17, 17x19, 22x24mm
KT-0808K	8PCS/PH	8x10, 10x12, 12x14, 13x15, 14x17, 16x18, 17x19, 22x24mm

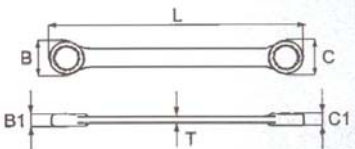

Double Ring Offset Wrench (0°)



- DROP FORGED
- CHROME VANADIUM SEEL
- A. MIRROR POLISHED
- B. SATIN PLATED

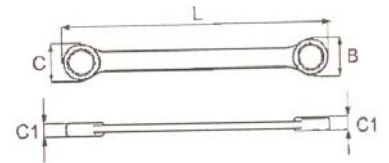

ART NO.	SIZE (mm)	A (mm)	B (mm)	C (mm)	L (mm)
KT-0607F	6x7	10.0	11.2	4.7	100
KT-0809F	8x9	12.5	14.0	5.2	115
KT-1012F	10x11	15.5	16.5	6.4	128
KT-1213F	12x13	18.5	20.5	7.3	143
KT-1415F	14x15	21.0	22.5	7.3	157
KT-1617F	16x17	23.5	24.5	8.5	168
KT-1719F	17x19	25.0	27.5	9.0	189
KT-1819F	18x19	26.0	27.5	9.2	189
KT-2123F	21x23	31.2	33.8	11.6	217
KT-2224F	22x24	31.2	33.8	11.6	217
KT-2628F	26x28	36.5	40.5	11.8	263
KT-2729F	27x29	38.8	43.5	12.8	285
KT-3032F	30x32	42.5	45.0	12.8	285

POUCH BAG SET

ART NO.	SET	SIZE (mm)
KT-0608K	8PCS/PH	6x7, 8x9, 10x11, 12x13, 14x15, 16x17, 18x19, 22x24mm
KT-0612K	12PCS/PH	6x7, 8x9, 10x11, 12x13, 14x15, 16x17, 18x19, 21x23, 22x24, 26x28, 27x29, 30x32mm

Offset 0° Double Torx Wrench

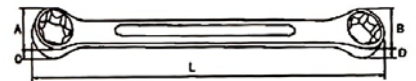

MERTIC SIZE

ART NO.	SIZE (mm)	A (mm)	B (mm)	C (mm)	D (mm)	L (mm)
KT-1608T	E6XE8	7.3	9.7	4.2	5.3	114
KT-1711T	E7XE11	10.8	14.8	5.2	7.2	130
KT-1012T	E10XE12	12.3	15.1	6.5	7.7	141
KT-1418T	E14XE18	17.0	21.1	8.2	10.3	180
KT-1622T	E16XE22	19.7	27.3	8.4	11.8	205
KT-2024T	E20XE24	23.9	27.9	11.0	12.6	224

POUCH BAG SET

ART NO.	SET	SIZE (mm)
KT-0604K	4PCS/PH	E6XE8, E7XE11, E10XE12, E14XE18, E16XE22, E20XE24mm

Double Ring Offset Wrench (75°)



- DROP FORGED
- CHROME VANADIUM SEEL
- A. MIRROR POLISHED
- B. SATIN PLATED

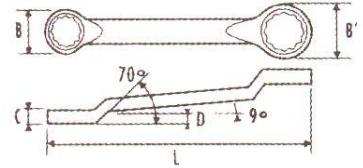

METRIC SIZE:

ART NO.	SIZE (mm)	B x B1 (mm)	C (mm)	D (mm)	L (mm)	ART NO.	SIZE (mm)	B x B1 (mm)	C (mm)	D (mm)	L (mm)
KT-08-203	6x7	10.7x12.2	5.7	6.3	168	KT-08-223	17x19	28.2x29.7	10.1	10.4	292
KT-08-204	6x8	10.7x12.2	5.7	6.3	168	KT-08-224	18x19	28.2x29.7	10.1	10.4	292
KT-08-205	8x9	13.6x15.1	6.7	7	183	KT-08-226	17x22	31.1x34.0	10.9	11.4	318
KT-08-206	8x10	13.6x15.1	6.7	7	183	KT-08-227	19x21	31.1x34.0	10.9	11.4	318
KT-08-207	9x11	16.6x18.0	7.4	7.7	198	KT-08-228	19x22	31.1x34.0	10.9	11.4	318
KT-08-208	10x11	16.6x18.0	7.4	7.7	198	KT-08-230	20x22	31.1x34.0	10.9	11.4	318
KT-08-209	10x12	16.6x18.0	7.4	7.7	198	KT-08-231	21x23	32.6x35.5	11.2	11.6	327
KT-08-211	11x13	19.5x20.9	8.1	8.4	217	KT-08-237	24x26	36.9x41.0	12.4	13.4	329
KT-08-212	12x13	19.5x20.9	8.1	8.4	217	KT-08-238	24x27	36.9x41.0	12.4	13.4	329
KT-08-213	12x14	19.5x20.9	8.1	8.4	217	KT-08-241	25x28	38.4x42.8	12.7	13.7	347
KT-08-218	14x15	22.4x23.7	8.8	9.1	239	KT-08-248	30x32	45.5x48.5	14.4	15.2	362
KT-08-219	14x17	22.4x23.7	8.8	9.1	239	KT-08-252	36x41	53.0x62.1	17.4	19.2	460
KT-08-220	15x17	25.3x26.7	9.5	9.8	260	KT-08-255	38x42	53.0x62.1	17.4	19.2	460
KT-08-221	16x17	25.3x26.7	9.5	9.8	260	KT-08-260	46x50	69.5x75.2	19.5	22.5	540

POUCH BAG SET

ART NO.	SET	SIZE (mm)
KT-0406K	6PCS	6x7, 8x9, 10x11, 12x13, 14x15, 16x17mm
KT-0407K	7PCS	6x7, 8x9, 10x11, 12x13, 14x15, 16x17, 18x19mm
KT-0408K	8PCS	6x7, 8x9, 10x11, 12x13, 14x15, 16x17, 18x19, 20x22mm
KT-0412K	12PCS	6x7, 8x9, 10x11, 12x13, 14x15, 16x17, 18x19, 20x22, 21x23, 24x27, 25x28, 30x32mm

Double Ring Offset Wrench (45°)



METRIC SIZE:

ART NO.	SIZE(mm)	L (mm)	C (mm)	B (mm)	ART NO.	SIZE(mm)	L (mm)	C (mm)	B (mm)
KT-08-704	6x8	165	10.6	13.0	KT-08-7021	16x17	237	24.0	26.0
KT-08-706	8x9	70	14.5	16.5	KT-08-7024	18x19	270	28.0	29.5
KT-08-707	8x10	170	14.5	16.5	KT-08-7030	20x22	292	29.0	32.5
KT-08-708	10x11	180	15.0	17.5	KT-08-7031	21x23	327	32.5	34.5
KT-08-709	10x12	195	17.2	19.2	KT-08-7034	22x24	327	32.5	34.5
KT-08-7012	12x13	206	20.0	22.0	KT-08-7037	24x26	362	34.5	36.5
KT-08-7013	12x14	206	20.0	22.0	KT-08-7041	25x28	372	39.8	42.4
KT-08-7018	14x15	232	22.0	24.0	KT-08-7048	30x32	392	43.5	45.0
KT-08-7019	14x17	232	22.0	25.0					

POUCH BAG SET

ART NO.	SET	SIZE (mm)
KT-0706K	6PCS	10x12, 12x14, 14x17, 17x19, 19x21, 22x24mm
KT-0708K	8PCS	6x7, 8x9, 10x11, 12x13, 14x15, 16x17, 18x19, 20x22mm

Flare Nut Wrench

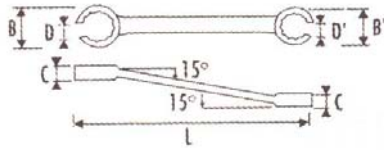

METRIC SIZE:

ART NO.	SIZE (mm)	B x B1 (mm)	CxC1 (mm)	DxD1 (mm)	L (mm)	ART NO.	SIZE (mm)	B x B1 (mm)	CxC1 (mm)	DxD1 (mm)	L (mm)
KT-05-606	8x9	18.0x20.0	7.0x8.5	6.0x7.0	145	KT-05-624	18x19	30.0x32.2	12.4x14.0	14.0x15.0	210
KT-05-607	8x10	18.0x20.0	7.0x8.5	6.0x7.0	145	KT-05-625	17x22	30.0x38.0	12.0x16.0	14.0x17.0	230
KT-05-608	10x11	20.0x22.0	8.5x9.0	7.0x8.5	152	KT-05-628	19x22	32.0x38.0	14.0x16.0	15.0x17.0	233
KT-05-609	10x12	20.0x22.2	8.5x9.0	7.0x9.0	152	KT-05-631	21x23	38.0x42.0	16.0x17.0	17.0x18.0	252
KT-05-611	11x13	22.0x26.0	9.0x10.5	8.5x10.0	165	KT-05-634	22x24	38.0x42.0	16.0x17.0	17.0x18.0	252
KT-05-612	12x13	22.0x26.0	9.0x10.5	8.5x10.0	165	KT-05-638	24x27	42.0x46.0	17.0x18.0	18.0x20.0	265
KT-05-613	12x14	24.0x28.0	9.5x11.0	9.0x11.0	178	KT-05-641	25x28	42.0x46.0	17.0x18.0	18.0x20.0	265
KT-05-614	13x14	24.0x28.0	9.5x11.0	9.0x11.0	178	KT-05-648	30x32	50.0x52.0	21.0x23.0	22.0x24.0	285
KT-05-619	14x17	28.0x30.0	11.0x12.0	11.0x14.0	16	KT-05-651	32x36	52.0x60.0	23.0x25.0	22.0x25.0	315
KT-05-621	16x17	28.0x30.0	11.0x12.0	11.0x14.0	196	KT-05-654	36x41	60.0x67.0	25.0x27.0	25.0x32.0	350
KT-05-623	17x19	30.0x32.2	12.0x14.0	14.0x15.0	210						

POUCH BAG SET

ART NO.	SET	SIZE (mm)
KT-0506KF	6PCS	8x10, 10x11, 11x13, 12x14, 17x19, 19x22mm
KT-0507KF	7PCS	8x10, 10x11, 11x13, 12x14, 17x19, 19x22, 24x27mm

6 Point Flare Nut Wrench Set



KT-520C-S6 , KT-520C-S4 → Satin Finish
KT-520C-M6, KT-520C-M4 → Mirror Finish

- For tube connections, union nuts and male fittings for pipes
- Heads bent 15°
- 6 point end slotted at 30°, 12 point end at 15°
- Chrome-Vanadium
- Surface chrome-plated.

ITEM NO.	SIZE (mm)	ITEM NO.	SIZE(mm)
KT-520C-089	8x9	KA-520C-1214	12x14
KT-520C-0810	8x10	KT-520C-1314	13x14
KT-520C-0911	9x11	KT-520C-1415	14x15
KT-520C-1012	10x12	KT-520C-1517	15x17
KT-520C-1113	11x13	KT-520C-1618	16x18
KT-520C-1213	12x13	KT-520C-1719	17x19

ART NO.	SET	SIZE (mm)
KT-520C-S6 KT-520C-M6	6PCS	8x10, 10x12, 11x13, 12x14, 15x17, 17x19mm
KT-520C-S4 KT-520C-M4	4PCS	8x10, 10x12, 13x14, 15x17mm

Starter & Block Wrench



MERTIC SIZE

ART NO.	SIZE (mm)	A (mm)	B (mm)	C (mm)	D (mm)	L (mm)	Weight (g)
KT-0812B	10x12	15.6	17.9	7	6.6	142	57
KT-0813B	11x13	17.9	20.7	8.0	8.2	164	90
KT-0815B	14x17	21.4	25.1	8.2	9.2	190	133
KT-0817B	15x17	24.8	27.7	8.8	9.6	216	166
KT-0818B	16x18	24.8	27.7	8.8	9.6	216	166
KT-0822B	19x22	27.6	33.0	10.0	11.1	255	244

TRAY SET

ART NO.	SET	SIZE (mm)
KT-0805K	5PCS/PH	10x12, 11x13, 14x17, 16x18, 19x22mm

72 Tooth Gear Wrench



- DROP FORGED
- CHROME VANADIUM SEEL
- A. MIRROR POLISHED
- B. SATIN PLATED

ART NO.	SIZE (S1) (mm)	O1 (mm)	O2 (mm)	T1 (mm)	T2 (mm)	B1 (mm)	W1 (mm)	L1 (mm)
KT-0110G	10mm	20.4	22.2	5.0	9	9.5	3.6	162
KT-0111G	11mm	21.5	23.5	5.5	9	10.0	4.0	164
KT-0112G	12mm	24.5	25.3	5.5	9	11.2	4.2	170
KT-0113G	13mm	26.6	26.5	6.0	9	11.8	4.2	180
KT-0114G	14mm	29.1	30.3	6.0	10	12.5	4.5	191
KT-0115G	15mm	31.1	31.0	6.5	10	13.2	4.6	201
KT-0116G	16mm	33.2	31.8	7.0	10	14.0	4.6	210
KT-0117G	17mm	34.8	35.0	7.0	11	14.6	5.3	225
KT-0118G	18mm	36.8	35.5	8.0	11	15.7	5.8	238
KT-0119G	19mm	38.8	36.0	9.0	11	16.8	6.3	247

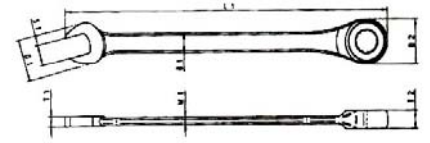

21PC - 72 Tooth Gear Wrenches & Go-Through-Socket Set

ART NO.	Q'TY	CONTAINS & SIZE
KT-0110GK	10PCS	72 Tooth gear wrenches 10, 11, 12, 13, 14, 15, 16, 17, 18, 19mm
	10PCS	Go Through & Hexagon Dr. Socket 10, 11, 12, 13, 14, 15, 16, 17, 18, 19mm
	1PC	Steel Case



Go-through & Hexagon Drive Socket

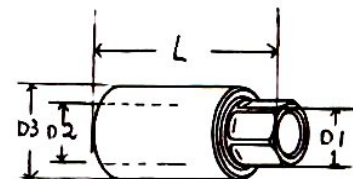

ART NO.	SIZE (mm)	D1 (mm)	D2 (mm)	D3 (mm)	L (mm)
KT-6610T	10	10	10	15.3	35
KT-6611T	11	11	11	16.3	35
KT-6612T	12	12	12	17.8	35
KT-6613T	13	13	13	18.8	35
KT-6614T	14	14	14	19.8	37
KT-6615T	15	15	15	21.8	37
KT-6616T	16	16	16	22.8	37
KT-6617T	17	17	17	24.4	39
KT-6618T	18	18	18	25.8	39
KT-6619T	19	19	19	26.6	39

Combination Wrench – Open & Socket End

- DROP FORGED
- CHROME VANADIUM SEEL
- A. MIRROR POLISHED
- B. SATIN PLATED



MERTIC SIZE

ART NO.	SIZE (mm)	L (mm)	B (mm)	D (mm)	S1 (mm)	S2 (mm)
KT-03-208	8	169	19	13	6.2	13
KT-03-209	9	169	19	14	6.2	14
KT-03-210	10	180	20.5	14.7	6.4	14.7
KT-03-211	11	192	24.7	15.8	6.6	15.8
KT-03-212	12	192	24.7	17.7	6.6	17.7
KT-03-213	13	210	28.3	19	7.1	19
KT-03-214	14	228	32.6	20	7.1	20
KT-03-215	15	238	33.4	21.8	7.2	21.8
KT-03-216	16	238	33.5	23.8	7.5	23.8
KT-03-217	17	235	35.6	23.8	7.5	23.8
KT-03-218	18	255	41.1	26	8.5	26
KT-03-219	19	255	41.1	26	8.5	26

POUCH BAG SET

ART NO.	SET	SIZE (mm)
KT-0307K	7PCS/PH	8, 10, 12, 13, 14, 17, 19mm
KT-0317K	7PCS/PH	9, 10, 12, 13, 14, 17, 19mm

Flexible Double Socket Wrench



MERTIC SIZE

ART NO.	SIZE (mm)	L (mm)	B (mm)	D (mm)	S1 (mm)	S2 (mm)
KT-03-607	6x7	180	10.9	10.9	180	180
KT-03-809	8x9	182	13.8	13.8	182	182
KT-03-111	10x11	202	15.9	15.9	202	202
KT-03-123	12x13	224	18.7	18.7	224	224
KT-03-145	14x15	241	21.8	21.8	241	241
KT-03-167	16x17	258	23.8	23.8	258	258
KT-03-189	18x19	173	25.8	25.8	273	273
KT-03-222	20x22	173	30.9	30.9	273	273
KT-03-223	21x23	303	32.6	32.6	303	303

POUCH BAG SET

ART NO.	SET	SIZE (mm)
KT-0907K	7PCS/PH	6x7, 8x9, 10x11, 12x13, 14x15, 16x17, 18x19mm
KT-0917K	7PCS/PH	8x9, 10x11, 12x13, 14x15, 16x17, 18x19, 20x22mm
KT-0909K	9PCS/PH	6x7, 8x9, 10x11, 12x13, 14x15, 16x17, 18x19, 20x22, 21x23mm



KA-T10008K LED Spanner with 72 Tooth Gear Wrench

- Battery: No. CR626, SR626, AG4, LR626, 377A, A177 1.5V
- Maximum out-put is two or three hours, Normal use until no light is 120 hours.
- LED light: Effective function time is 30,000 hours.
- Have to wiped the mess after using in water or oil, as it isn't overall water-proof
- Size: 8-10-11-12-13-14-15-16-17-19mm

Item No.	Size
KA-T10008	8MM
KA-T10010	10MM
KA-T10011	11MM
KA-T10012	12MM
KA-T10013	13MM

Item No.	Size
KA-T10014	14MM
KA-T10015	15MM
KA-T10016	16MM
KA-T10017	17MM
KA-T10019	19MM



KA-T10001K

4PCS: 10, 13, 17, 19mm



KA-T10002K

7PCS: 8, 10, 13, 14, 15, 17, 19mm



KA-T10003K

5PCS: 8, 10, 11, 12, 13mm



KA-T10004K

10PCS: 8, 10, 11, 12, 13, 14, 15, 16, 17, 19mm

LED Lighting Ratchet Wrench



Item No.	Description
KA-T10006-41	10mm LED Light Ratchet Wrench ■ 1/4" Dr. x 10mm adaptor · 1/4"Dr. x 10mm Hex Bit
KA-T10006-83	13mm LED Light Ratchet Wrench ■ 3/8" Dr. x 13mm adaptor · 3/8"Dr. x 13mm Hex Bit
KA-T10006-21	19mm LED Light Ratchet Wrench ■ 1/2" Dr. x 19mm adaptor · 1/2"Dr. x 19mm Hex Bit
KA-T10006K	9pcs LED Light Ratchet Wrench (10, 13, 19mm) ■ 1/4", 3/8", 1/2" Dr. x 10, 13, 19 mm adaptor ■ 1/4", 3/8", 1/2" Dr. x 10, 13, 19mm Hex Bit



KA-T10005K 6pcs LED Lighting Ratchet Wrench

Contents:

- Size: 8, 10, 12, 13, 17, 19mm
- Quick release adaptor: 1/4", 3/8", 1/2"
- Hex bit: 1/4"

LED Extension Bar



ITEM NO.	Size
KA-T10007-3	1/2(M) x 1/2(F) x 3"
KA-T10007-5	1/2(M) x 1/2(F) x 5"
KA-T10007-10	1/2(M) x 1/2(F) x 10"
KA-T10007K	1/2(M) x 1/2(F) x 3", 5", 10"



Wobble LED Extension Bar

ITEM NO.	Size
KA-T20007-3	1/2(M) x 1/2(F) x 3"
KA-T20007-5	1/2(M) x 1/2(F) x 5"
KA-T20007-10	1/2(M) x 1/2(F) x 10"
KA-T20007K	1/2(M) x 1/2(F) x 3", 5", 10"





KA-1614 16pcs 3/4" & 1" Dr. Insert Bit Socket Set

- 5- TX Star: T60-T70-T80-T90-T100
- 4- Hexagon: 17-19-22-24mm
- 1- Star -E: E18-E20-E22-E24
- 1- Adaptor: 3/4"Dr.
- 1- Adaptor: 1"
- 1- Hexagon L-Key: 4mm



KA-1333 6pcs 1/2" Dr. Integral Spline Bit Socket Set

- One-Piece (Integral)
- 6pcs Spline
- Length: 30mmL
- Size: M10-M12-M14-M16-M18-M20



KA-1334 6pcs 1/2" Dr. Integral Torx Bit Socket Set

- One-Piece (Integral)
- 6pcs Torx (tamper)
- Length: 30mmL
- Size: T55H-T60H-T70H-T80H-T90H-T100H





Drive Rotor Stubby Ratchet (3/8" & 1/4" BIT)

ITEM	TYPE	D(mm)	T(mm)	TEETH	L	G	PCS	GW(kgs)
KT-372BGLS-1	3/8"	44	39.5	72	168mm	360g	60	22.5/0.6



3/8" & 1/4" 17 Penetrable Drive Rotor Stubby Ratchet

ITEM	TYPE	D(mm)	T(mm)	TEETH	L	G	PCS	GW(kgs)
KT-37217GLS	3/8"	44	15	72	165mm	300g	60	19/0.6
KT-27211GLS	1/4"	31.5	11	72	100mm	140g	100	15/0.6



Drive Rotor Stubby Ratchet (1/2" & 1/4" . 3/8" & 1/4")

ITEM	TYPE	D(mm)	T(mm)	TEETH	L	G	PCS	GW(kgs)
KT-4722GLS	1/2"	44	47	72	160mm	360g	60	22/0.6
KT-3722GLS	3/8"	44	43	72	160mm	360g	60	22/0.6



1/2" & 3/8" Drive Rotor Stubby Ratchet

ITEM	TYPE	D(mm)	T(mm)	TEETH	L	G	PCS	GW(kgs)
KT-472GLS	1/2"	44	36	72	160mm	360g	60	22/0.6
KT-372GLS	3/8"	44	32	72	160mm	360g	60	22/0.6



Drive Rotor Stubby Ratchet (3/8" & 1/4" BIT)

ITEM	TYPE	D(mm)	T(mm)	TEETH	L	G	PCS	GW(kgs)
KT-372BGLS	3/8"	44	38	72	160mm	360g	60	22/0.6



72T Drive Rotor Stubby Ratchet (1/2" & 3/8" , 3/8" & 1/4")

ITEM	TYPE	D(mm)	T(mm)	TEETH	L	G	PCS	GW(kgs)
KT-4723G	1/2"	39.5	51	72	260mm	600g	40	24.5/1.1
KT-3722G	3/8"	32	37.5	72	196mm	280g	60	18/0.6



1/2" & 3/8" 72T Drive Rotor Stubby Ratchet

ITEM	TYPE	D(mm)	T(mm)	TEETH	L	G	PCS	GW(kgs)
KT-472GLS-1	1/2"	44	40	72	168mm	360g	60	22.5/0.6
KT-372GLS-1	3/8"	44	40	72	168mm	360g	60	22.5/0.6



1/2" & 3/8" & 1/4" Reversible Ratchet Handle with Quick Release

ITEM	TYPE	D(mm)	T(mm)	TEETH	L	G	PCS	GW(kgs)
KT-472GQ	1/2"	39.5	40	72	257mm	580g	40	24/1.2
KT-372GQ	3/8"	32	32.5	72	195mm	280g	60	18/0.7
KT-272GQ	1/4"	25	23	72	147mm	140g	100	15/0.6



1/2" & 3/8" & 1/4" Reversible Ratchet Handle with Quick Release

ITEM	TYPE	D(mm)	T(mm)	TEETH	L	G	PCS	GW(kgs)
KT-472PQ	1/2"	40	40.5	36	255mm	640g	40	26/1.2
KT-372PQ	3/8"	32	32	36	180mm	350g	60	21.5/1.2
KT-272PQ	1/4"	25.5	23.5	36	125mm	140g	100	14.5/1.2



1/2" & 3/8" & 1/4" Rotor Ratchet

ITEM	TYPE	D(mm)	T(mm)	TEETH	L	G	PCS	GW(kgs)
KT-472PL	1/2"	49	41	72	280mm/11"	700g	32	23.5/1.2
KT-372PL	3/8"	43	31	72	220mm/8-1/2"	410g	60	25.5/1.2
KT-272PL	1/4"	32	23	72	140mm/5-1/2"	120g	100	13/1.2



1/2" & 3/8" & 1/4" (19-17-11) Penetrable Drive Rotor Ratchet

ITEM	TYPE	D(mm)	T(mm)	TEETH	L	G	PCS	GW(kgs)
KT-47219GL	1/2"	49	17	72	305mm	560g	32	19/1.2
KT-37217GL	3/8"	44	15	72	250mm	380g	60	23.5/1.2
KT-27211GL	1/4"	31	11	72	160mm	150g	100	16/1.2



1/2" & 3/8" & 1/4" (19-17-11) Penetrable Drive Rotor Ratchet

ITEM	TYPE	D(mm)	T(mm)	TEETH	L	G	PCS	GW(kgs)
KT-47219PL	1/2"	49	17	72	280mm	680g	32	22.5/1.2
KT-37217PL	3/8"	44	15	72	168mm	360g	60	22.5/1.1
KT-27211PL	1/4"	31	11	72	145mm	140g	100	15/0.6



1/2" & 3/8" & 1/4" Flex Head Ratchets

ITEM	TYPE	D(mm)	T(mm)	TEETH	L	G	PCS	GW(kgs)
KT-472GR	1/2"	49	41	72	430mm/16-1/2"	860g	30	26/1.3
KT-372GR	3/8"	43	31	72	250mm/9-1/2"	400g	60	24.5/1.2
KT-272GR	1/4"	32	23	72	190mm/7"	160g	100	16.5/1.2



1/2" & 3/8" & 1/4" Flex Head Ratchets

ITEM	TYPE	D(mm)	T(mm)	TEETH	L	G	PCS	GW(kgs)
KT-472PR	1/2"	49	41	72	400mm/15.5"	880g	20	18/1.2
KT-372PR	3/8"	43	31	72	230mm/8-1/2"	370g	60	22.5/1.2
KT-272PR	1/4"	32	23	72	170mm/6-1/2"	165g	100	17/1.2



1/2" & 3/8" & 1/4" Rotor Ratchet

ITEM	TYPE	D(mm)	T(mm)	TEETH	L	G	PCS	GW(kgs)
KT-472GL	1/2"	49	41	72	320mm/12"	690g	32	22.5/1.2
KT-372GL	3/8"	43	31	72	250mm/9-1/2"	400g	60	24.5/1.2
KT-272GL	1/4"	32	23	72	165mm/6"	130g	100	13.5/1.2



1" & 3/4" Reversible Ratchet Handle with Quick Release

ITEM	TYPE	D(mm)	T(mm)	TEETH	L	G	PCS	GW(kgs)
KT-848NR	1"	70	66	48	760mm	3800g	6	23/1.5
KT-648NR	3/4"	70	66	48	530mm	3100g	6	19/1.5



1/2" & 3/8" & 1/4" Reversible Ratchet Handle with Quick Release (PUSH)

ITEM	TYPE	D(mm)	T(mm)	TEETH	L	G	PCS	GW(kgs)
KT-448PQ	1/2"	43	40	48	251mm/10"	640g	32	20.5/1.3
KT-348PQ	3/8"	31	31	48	199mm/8"	315g	60	19.5/1.2
KT-248PQ	1/4"	25	24	48	140mm/5-1/2"	145g	10	15/1.2



3/8" Flex Head Ratchets

ITEM	TYPE	D(mm)	T(mm)	TEETH	L	G	PCS	GW(kgs)
KT-348PR	3/8"	32	33	48	235mm/9-1/4"	380g	50	20/1.2



1/2" & 3/8" & 1/4"
Reversible Ratchet Handle with Quick Release (PUSH)

ITEM	TYPE	D(mm)	T(mm)	TEETH	L	G	PCS	GW(kgs)
KT-448GQ	1/2"	43	40	48	263mm/10"	640g	40	26/1.2
KT-348GQ	3/8"	32	31	48	199mm/8"	310g	60	19/1.2
KT-248GQ	1/4"	25	24	48	147mm/5-1/2"	145g	100	15/1.2



1/2" Reversible Ratchet Handle with Quick Release

ITEM	TYPE	D(mm)	T(mm)	TEETH	L	G	PCS	GW(kgs)
KT-436NQ-1	1/2"	39.5	40	36	380mm	880g	25	23/0.6



1/2" Reversible Ratchet Handle with Quick Release

ITEM	TYPE	D(mm)	T(mm)	TEETH	L	G	PCS	GW(kgs)
KT-436PQ-1	1/2"	39.5	40	36	380mm	880g	25	23/0.6



1/2" Reversible Ratchet Handle with Quick Release

ITEM	TYPE	D(mm)	T(mm)	TEETH	L	G	PCS	GW(kgs)
KT-436GQ-1	1/2"	39.5	40	36	410mm	880g	25	23/0.6



1/2" & 3/8" & 1/4"
Reversible Ratchet Handle with Quick Release (PUSH)

ITEM	TYPE	D(mm)	T(mm)	TEETH	L	G	PCS	GW(kgs)
KT-436PQ	1/2"	40	40.5	36	255mm	640g	40	26/1.2
KT-336PQ	3/8"	32	32	36	180mm	350g	60	21.5/1.2
KT-236PQ	1/4"	25.5	23.5	36	125mm	140g	100	14.5/1.2



1/2" & 3/8" & 1/4"
Reversible Ratchet Handle with Quick Release (PUSH)

ITEM	TYPE	D(mm)	T(mm)	TEETH	L	G	PCS	GW(kgs)
KT-436GQ	1/2"	40	40.5	36	255mm	600g	40	4.5/1.2
KT-336GQ	3/8"	32	32	36	200mm	350g	60	21.5/1.2
KT-236GQ	1/4"	25.5	23.5	36	142mm	140g	100	14.5/1.2



1/2" Extension Ratchet Handle

ITEM	TYPE	D(mm)	T(mm)	TEETH	L	G	PCS	GW(kgs)
KT-424NR	1/2"	45	33	24	15"/20"	1000g	20	20.5/1
KT-436NR	1/2"	40	40.5	36	15"/24"	1160g	20	24/1



1/2" & 3/8" & 1/4"
Reversible Ratchet Handle with Quick Release (PUSH)

ITEM	TYPE	D(mm)	T(mm)	TEETH	L	G	PCS	GW(kgs)
KT-424N	1/2"	45	36.5	24	250mm/10"	620g	40	24.8/0.5
KT-324N	3/8"	35	32	24	190mm/8"	320g	70	22.5/0.5
KT-224N	1/4"	26	24	24	129mm/5"	120g	100	12.5/0.5



1/2" & 3/8" & 1/4"
Reversible Ratchet Handle with Quick Release (PUSH)

ITEM	TYPE	D(mm)	T(mm)	TEETH	L	G	PCS	GW(kgs)
KT-424PQ-1	1/2"	46.5	41	24	265mm/10"	780g	30	23.5/0.5
KT-324PQ	3/8"	35	31	24	197mm/8"	330g	70	23.1/0.5
KT-224PQ	1/4"	27	23.5	24	143mm/5-1/2"	135g	100	13.5/0.5



1/2" & 3/8" & 1/4"
Reversible Ratchet Handle with Quick Release (PUSH)

ITEM	TYPE	D(mm)	T(mm)	TEETH	L	G	PCS	GW(kgs)
KT-4242GQ-1	1/2"	46.5	41	24	276mm/10-1/2"	700g	32	23/1.2
KT-3242GQ	3/8"	35	31	24	214mm/8-1/2"	320g	60	19.5/1.2
KT-242GQ	1/4"	26.5	23.5	24	140mm/10"	140g	100	14.5/1.2
KT-4242GQ-2	1/2"	45.5	36.5	24	266mm/10"	600g	40	24.5/1.2



3/4" Reversible Ratchet Handle with Quick Release (PUSH)
HANDLE ALL STEEL Ø 24mm

ITEM	TYPE	D(mm)	T(mm)	TEETH	L	G	PCS	GW(kgs)
KT-624NQ	3/4"	46	61	24	510mm/20"	2600g	10	26.5/1.2
KT-624N	3/4"	64	55	24	510mm/20"	2600g	10	26.5/1.2



1" & 3/4" Reversible Ratchet Handle with Quick Release (PUSH)
HANDLE STEEL PIPE Ø 32mm

ITEM	TYPE	D(mm)	T(mm)	TEETH	L	G	PCS	GW(kgs)
KT-824NR	1"	70	66	24	800mm	4150g	6	25.5/1.3
KT-624QR	3/4"	64	61	24	510mm/20"	2710g	10	27.5/1.2
KT-624NR	3/4"	64	55	24	510mm/20"	2710g	10	27.5/1.2



1" Reversible Ratchet Handle
HANDLE ALL STEEL Ø 28mm

ITEM	TYPE	D(mm)	T(mm)	TEETH	L	G	PCS	GW(kgs)
KT-824	1"	70	66	24	670mm	4400g	6	27/1.3



1/2" Swivel Handle

ITEM	TYPE	L	G	PCS	GW(kgs)
KT-4300	1/2"	300mm	635g	40	25.5/0.6
KT-4335	1/2"	431mm	900g	20	20.5/0.6



1/2" High Handle

ITEM	TYPE	D(mm)	L	G	PCS	GW(kgs)
KT-4240G	1/2"	31	620mm	1000g	20	20/0.7



1" & 3/4" & 1/2" Sliding T-Handle

ITEM	TYPE	D(mm)	T(mm)	L	G	PCS	GW(kgs)
KT-8760	1"	49	83	760mm/30"	4300g	6	25.8/1.3
KT-6510	3/4"	39.5	64.5	510mm/20"	1580g	15	24/1.1
KT-4250	1/2"	24	41	250mm/10"	360g	50	18.5/0.5



1/2" Swivel Handle

ITEM	TYPE	L	G	PCS	GW(kgs)
KT-4320	1/2"	380mm	750g	20	15/0.6



1" & 3/4" High Handle

ITEM	TYPE	D(mm)	T(mm)	L	G	PCS	GW(kgs)
KT-8850F	1"	55	69	800mm	3850g	6	31.5/1.5
KT-6560F	3/4"	43	59	560mm	2400g	10	21/1.5



3/4" High Handle

ITEM	TYPE	D(mm)	T(mm)	L	G	PCS	GW(kgs)
KT-6240N	3/4"	43	59	620mm	2300g	10	23.5/1.5



KA-1336A / KA-1336B

Torque Screwdriver With Window Scale

- KA-1336A Torque 1~5 Nm(5~50 inch-pounds)
- KA-1336B Torque 2~10 Nm(10~80 inch-pounds)
- KA-1336C Torque 4~12 Nm(30~90 inch-pounds)



KA-1336C



KA-1336AK
Include 32-bits and 1-bit holder

Mechanical Digital Display Torque Wrench



Item No.	KA-1335A	KA-1335B	KA-1335C (KA-1335CR)
Drive	1/4"	3/8"	1/2"
Net Weight	840g	950g	1220g
Tool Length	390mm	390mm	490mm
Head Depth	31.8mm	35.7mm	43.2mm
Head Width	35.1mm	35.1mm	38.7mm
Display Range	10 – 50 N-m	20 – 100 N-m	40 – 200 N-m
Accuracy	±3%	±3%	±3%
Unit Selection	Kg-cm, Kg-m, In-lb, Ft-lb, N-m		
Battery	3 Volt Battery CR2032		



Digital Torque Wrench

Specifications:

Model No.	Length	Dr.	Range	Accuracy
KA-1624	280mm	1/4"	16-80N-m(11.8-59.0lb-ft)	±3%
KA-1626	310mm	3/8"	27-135N-m(19.9-99.6lb-ft)	±2%
KA-1627	440mm	1/2"	40-200N-m(29.5-147.5lb-ft)	±2%

- 50 Memory Record
- Target Value Setting
- Peak and Trace mode
- 5 unit set:
- (N-m, ft-lt, in-lb, kg-m, kg-cm)
- Auto Off: 80seconds
- Battery: CR2032 x 1pc
- 36T quick release



Digital Ratchet Wrench

Specifications:

Model No.	Length	Dr.	Range	Accuracy
KA-1628	210mm	1/4"	6-30N-m(4.4-22.1lb-ft)	±3%